

# PERFORMANCE ADVANTAGE COMPANY



## 2021 FIRE & EMS INDUSTRY CATALOG



TOOL MOUNTING SYSTEMS  
[PACTOOLMOUNTS.COM](http://PACTOOLMOUNTS.COM)

LAW ENFORCEMENT - MILITARY - LANDSCAPING - UTILITY - TOWING & RACING



**OUR COMMITMENT TO THE TEAM  
APPROACH INCLUDES YOU,  
OUR NUMBER ONE PRIORITY.**



We take pride in being YOUR FIRST CHOICE for proper, safe and efficient tool mounting!



**PAC Founder/Owner: Dick Young  
Vice President: Greg Young  
President: Jim Everett**



**Sales Team: Dean Mayhew, Greg Young,  
Tammy Trzepacz, Tom Trzepacz, Mike McGuire**



**Performance Advantage Company Team**

**TRADITION - SAFETY - VALUE**

# TRADITION - SAFETY - VALUE

In the past 25 years PAC has grown from the basement of company founder Dick Young to an operation with over 600 points of distribution in North America and sales in 38 countries around the globe. All this based on the concept of offering Top Quality products combined with the very best Customer Service. The cornerstone of all this is based on our outstanding staff members. They are committed to giving our customers the very best in assistance and overall customer service.

Our history of innovation and our collective experience guide PAC to create products to outlast and outperform. You can expect high quality and value when purchasing PAC products. We are highly recognized in the industries we serve for our attention to detail and overall customer service. Additionally, PAC products are tested to the highest standards and are compliant with National Fire Protection Association (NFPA) 1901 standards and MIL-S901D military shock specifications. And PAC offers a LIFETIME WARRANTY! If any PAC product fails under normal use it is replaced, free of charge.

In recent years we have grown beyond the Fire Market. We have applied our tool mounting knowledge to customers in Law Enforcement, Towing and Tow Vehicles, Homeland Security, Public Utility and the Green Industry, too. Check us out today!!

**For PAC Brackets - Contact us to request one of our Market Specific Catalogs!**



# PACTOOLMOUNTS.COM



PAC continues to lead during the Coronavirus pandemic:

Following NYS & CDC guidelines, PAC maintains a 100% on-site workforce. Throughout the pandemic, PAC never stopped critical functions. Our hearts go out to those affected by this illness or the lockdowns.

We know our customers require urgency - an apparatus out of service risks lives! That is why we recognize the entire talented staff of PAC! Rest assured, our raw material supply is strong; thanks to our dedicated purchasing and quality team, along with US-based manufacturing.

Our industry-leading shipping speed continues to set PAC apart from the competition. While outside of our control, Freight carriers have experienced several pandemic related issues. Therefore, we must accommodate more transit time for large, palletized orders. Please be mindful of this when ordering.

One final note – At this time, the PAC headquarters is continuing a policy of NO VISITORS. Send all purchase orders to [orders@pactoolmounts.com](mailto:orders@pactoolmounts.com). Our customer service staff IS ALWAYS AVAILABLE by phone or email. Stay healthy and God Bless!

Thank you for your support of PAC products!  
Greg Young  
VP, Performance Advantage Co.

## TESTING AND CERTIFICATION

A variety of PAC products are tested and certified to meet and exceed the NFPA 1901 9G impact standard. PAC's NFPA Compliant products have been Tested and certified at the Akron Rubber Development Laboratory, Akron, Ohio.

For a list of our 9G Certified Products  
or a copy of PAC's Certificate of Compliance,  
please contact us at 888-514-0083.



**PAC REGULARLY DISPLAYS OUR PRODUCT LINES AT THE TOP INDUSTRY SHOWS! SOMETIMES WE JUST GO TO SHOWS TO MEET PEOPLE LIKE YOU. PAC PRODUCTS CAN ALSO BE SEEN AT THE BOOTHS OF OUR DEALERS AND CUSTOMERS. IF YOU WANT MORE INFORMATION ABOUT SEEING PAC IN PERSON OR BECOMING A PAC DEALER, PLEASE CALL 888-514-0083!**

**FIRE, RESCUE & EMS**

**LAW ENFORCEMENT - MILITARY - LANDSCAPING - UTILITY - TOWING & RACING**



# PRODUCT INDEX

## Brackets & Kits - Positive and Friction Locking

Handlelok	P/N 1004	p. 6
Jumbo Lok	P/N 1070	p. 6
Fastlok Adjust. Kit - Standard	P/N K5020	p. 7
Fastlok Adjust. Kit - Long	P/N K5020L	p. 7
Adjustamount Kit - Short	P/N K5006S	p. 8
Adjustamount Kit - Standard	P/N K5006	p. 8
Adjustamount Kit - Long	P/N K5006L	p. 8
Adjustamount Kit - Short HD	P/N K5006HDS	p. 9
Adjustamount Kit - Standard HD	P/N K5006HD	p. 9
Adjustamount Kit - Long HD	P/N K5006HDL	p. 9
Super Adjust. Kit - Short	P/N K5050S	p. 10
Super Adjust. Kit - Standard	P/N K5050	p. 10
Super Adjust. Kit - Long	P/N K5050L	p. 10
Super Adjust. Kit - Short HD	P/N K5050HDS	p. 11
Super Adjust. Kit - Standard HD	P/N K5050HD	p. 11
Super Adjust. Kit - Long HD	P/N K5050HDL	p. 11
Mini Loks	P/N 1101-	p. 12
Hooklok	P/N 1001	p. 12
Toolok-HD	P/N 1003-HD	p. 13
Grip Mount	P/N 1085	p. 13
Coil-Lok	P/N 1021	p. 15
Stow-N-Loks	P/N 1005 (S)	p. 16
Flexmounts HD	P/N 1002(S)HD	p. 17

## Brackets - Hangers, Hooks and Stabilizing

GM Hook	P/N 1028	p. 18
Mini Hook	P/N 1110	p. 18
Loop Hook	P/N 1027	p. 19
Universal Hanger	P/N 1019	p. 19
Hookmount	P/N 1029	p. 20
Tie Down Mount Kit	P/N K3021	p. 20
Tie Down Mount - Double Shackle	P/N K3021-D	p. 20
Pole Mounts	P/N 1048-1-	p. 21
Universal Mount	P/N 1007	p. 21

## Cylinder/Container Family

Utility Pocket	P/N 1116	p. 22
Gas & Oil Mounts	P/N 1041-	p. 22
Cylinder Mounts	P/N 1043-	p. 23
Rectangular Mounts	P/N 1046-	p. 24
Can Mounts	P/N 1048-4-	p. 24

## Brackets & Kits - Tool Specific

Universal Saw Kit	P/N K5030	p. 25
Halligan Tool Mount Kit	P/N K5032	p. 25
Ironslok	P/N K5003	p. 26
Ironslok-HD	P/N K5003-HD	p. 26
Storz 4, 5 & 6" Loks	P/N 1040-	p. 27
Adapter Loks 1-1/2" - 2"	P/N 1042-	p. 28
Bolt Cutter Kit	P/N K5029-1	p. 29
Tool Hanger Kit	P/N K5009	p. 30
Sledge Hanger/Pocket Kit (8-12#)	P/N K5010-12	p. 30
Flathead Axe Hanger/Pocket Kit	P/N K5011	p. 31
Pickhead Axe Hanger/Pocket Kit	P/N K5012	p. 31
Vent Saw Kit	P/N K5025	p. 33

## Brackets & Kits - Heavy Rescue Tool Mounting

Strut Base Mount	P/N 2076	p. 34
Strut Mount Kit	P/N K1022	p. 34
Heavy Rescue Mt. Kit Fastlok	P/N K5035FL	p. 35
Heavy Rescue Mt. Kit Jumbo Lok	P/N K5035JL	p. 35
Heavy Rescue Mt. Kit Super Adjst.	P/N K5035SA	p. 35
Spreader Base Pocket Fastlok	P/N K5026FL	p. 36
Spreader Base Pocket Jumbo Lok	P/N K5026JL	p. 36
Spreader Base Pkt. Super Adjst.	P/N K5026SA	p. 36
Ram Base Mt. Kit Fastlok	P/N K1022FL	p. 37
Ram Base Mt. Kit Jumbo Lok	P/N K1022JL	p. 37
Ram Base Mt. Kit Super Adjst.	P/N K1022SA	p. 37
Amkus Cutter/Spreader Kit	P/N K5021	p. 38
Amkus Cutter/Combi Kit	P/N K5022	p. 38
Amkus Ram Kit	P/N K5023	p. 39
Amkus Spreader/Combi Kit	P/N K5024	p. 39

## SCBA Bottle Storage

Standard Cylinder Mate	P/N CM6000	p. 41
Extended Cylinder Mate	P/N CM6060	p. 41
Cylinder Mate Cart (12 Pack)	ASSORTED	p. 42
Cylinder Mate Cart (16 Pack)	ASSORTED	p. 42

## Additional Mounting Products & Accessories

PAC Challenge Coin		p. 15
Label Plates	P/N LP002-10	p. 43
Conspicuity Markings	ASSORTED	p. 43
PAC Strut	P/N 2019	p. 44
PAC Strut HD	P/N 2020	p. 44
PAC Strut Channel Cushion	P/N 8006	p. 45
Shelf Mount	P/N PSM	p. 45
Mini Dual Corner Connector	P/N 3018	p. 46
Dual Trac Corner Connector	P/N 3027	p. 46
Cup Mount	P/N 1033	p. 46
Traclok Packs	P/N 7002-	p. 47
Channel Nuts	ASSORTED	p. 47

## Aluminum Pac Trac Products

See this section, starting on page 49, for an overview of our PAC TRAC family of products.

**For more detailed information, request our Aluminum Catalog.**



**PAC offers mounting options for nearly all makes and models of Heavy Rescue Equipment. Our line extends beyond our catalog. For your specific needs with Hurst, Holmatro etc. please contact us!**

# HANDLELOK

**PAC**

<b>STRAP COLORS</b> BLACK YELLOW ORANGE	<b>PRODUCT NUMBER</b> 1004-B 1004-Y 1004-OR
<b>MOUNTING HARDWARE (INCLUDED)</b>	FLAT SURFACES PAC TRAC
<b>MOUNTING HARDWARE (OPTIONAL)</b>	REFER TO PAGE 46 – INSERTS & CHANNEL NUTS
<b>PRODUCT WT. DIMENSIONS</b>	0.4 lbs. 3.9" L x 1.8" W x 4.0" H
<b>GRIP RANGE</b>	1.75" Max

The Handlelok provides an adjustable positive locking method to secure axes, hammers, bars and many other tools and equipment. The STRETCHLOK strap allows instant release.

List Price: \$39.95

PLEASE SPECIFY STRAP COLOR



- **NEW Slotted mounting hole allows for more mounting versatility!**
- 2 pivot positions
- Molded from high quality materials
- Soft textured pad for extra grip.
- Weather, UV resistant
- Non-conductive
- Can be mounted horizontally or vertically

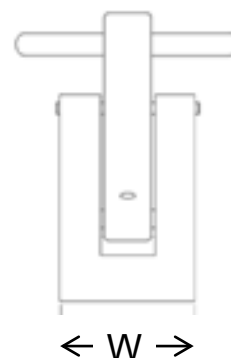
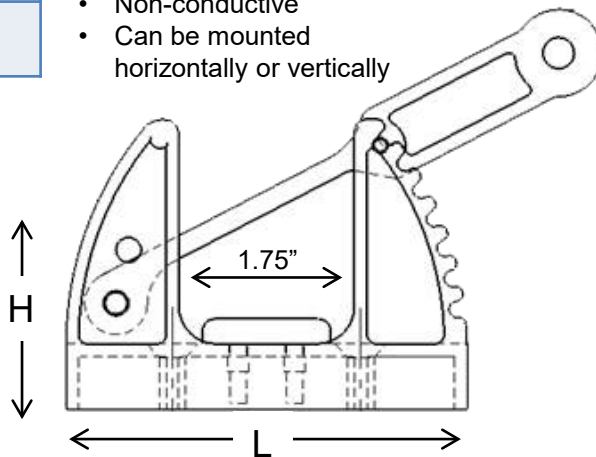

# JUMBO LOK

**PAC**

<b>STRAP COLORS</b> BLACK YELLOW ORANGE	<b>PRODUCT NUMBER</b> 1070-B 1070-Y 1070-OR
<b>MOUNTING HARDWARE (INCLUDED)</b>	FLAT SURFACES PAC TRAC
<b>MOUNTING HARDWARE (OPTIONAL)</b>	REFER TO PAGE 46 – INSERTS & CHANNEL NUTS
<b>PRODUCT WT. DIMENSIONS</b>	1.0 lbs. 7.3" L x 2.3" W x 4.6" H
<b>GRIP RANGE</b>	3.25" Max

The Jumbo Lok is a large positive locking bracket with FOUR strap pivot positions providing an extensive grip range for a wide variety of tools and equipment.

List Price: \$62.95

PLEASE SPECIFY STRAP COLOR



- **Now with 4 pivot positions!**
- Molded from high quality materials
- Soft textured pad for extra grip
- Weather, UV resistant
- Non-conductive
- Can be mounted horizontally or vertically

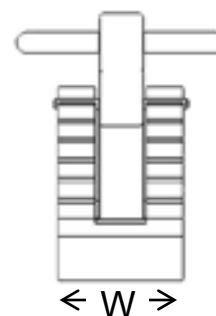
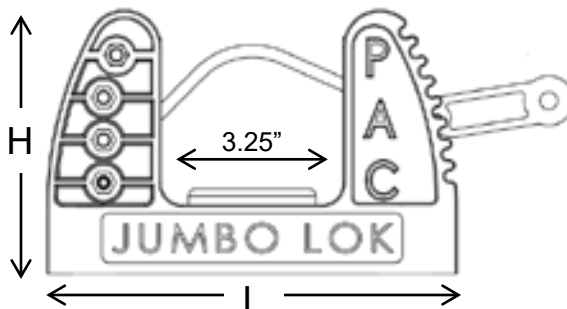

# FASTLOK ADJUSTAMOUNT KIT - STANDARD

<b>STRAP COLORS</b> BLACK YELLOW ORANGE	<b>PRODUCT NUMBER</b> K5020-B K5020-Y K5020-OR
<b>MOUNTING HARDWARE (INCLUDED)</b>	REFER TO PAGE 46 – INSERTS & CHANNEL NUTS
<b>PRODUCT WT. DIMENSIONS</b>	3.0 lbs. 12" L x 3.75" W x 6.34" H
<b>GRIP RANGE</b>	8.12" Max

Securing larger and heavier items is now even easier with the Standard Fastlok!

- Easily and quickly secure equipment - even with gloves on.
- Track base provides fast setup and adjustment to mount a wide variety of equipment such as:
  - Fire extinguishers
  - Air cylinders
  - Hydraulic pumps
  - Rescue tools
  - Chain saws
  - Oxygen cylinders
  - And many more!
- Easily Re-adjustable with a 25" long strap.
- No metal to metal contact
- UV resistant

List Price: \$119.95

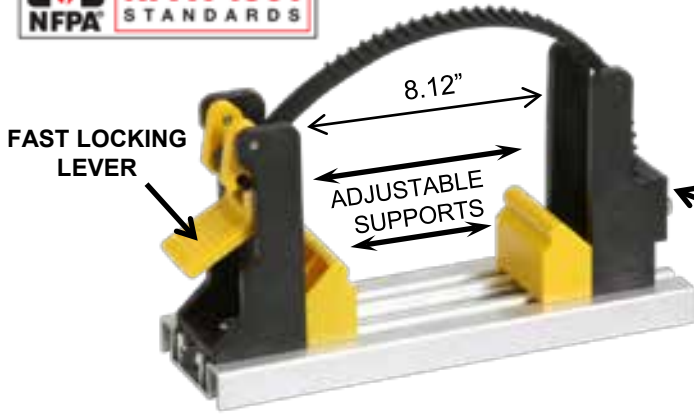

ADJUSTABLE STRAP LENGTH



# FASTLOK ADJUSTAMOUNT KIT - LONG

<b>STRAP COLORS</b> BLACK YELLOW ORANGE	<b>PRODUCT NUMBER</b> K5020L-B K5020L-Y K5020L-OR
<b>MOUNTING HARDWARE (INCLUDED)</b>	REFER TO PAGE 46 – INSERTS & CHANNEL NUTS
<b>PRODUCT WT. DIMENSIONS</b>	3.8 lbs. 18" L x 3.75" W x 6.34" H
<b>GRIP RANGE</b>	14.12" Max

Securing larger and heavier items is now even easier with the Long Fastlok!

List Price: \$134.95

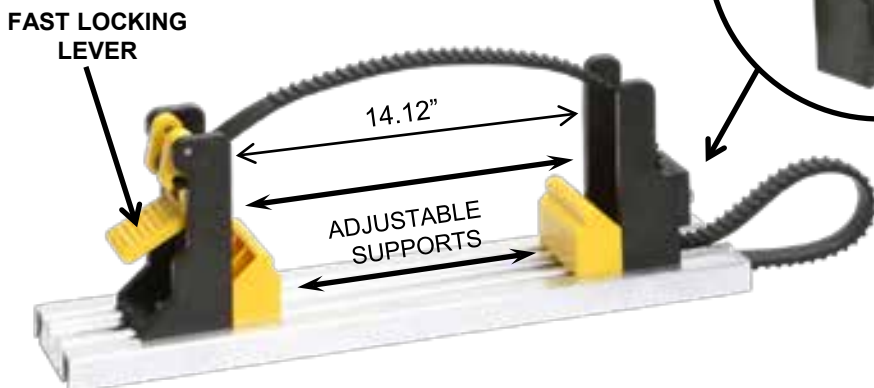

ADJUSTABLE STRAP LENGTH



# ADJUSTAMOUNT KIT W/PAC STRUT - SHORT



<b>STRAP COLORS</b> BLACK YELLOW ORANGE	<b>PRODUCT NUMBER</b> K5006S-B K5006S-Y K5006S-OR
<b>MOUNTING HARDWARE (INCLUDED)</b>	FLAT SURFACES PAC TRAC
<b>MOUNTING HARDWARE (OPTIONAL)</b>	REFER TO PAGE 46 – INSERTS & CHANNEL NUTS
<b>PRODUCT WT. DIMENSIONS</b>	1.6 lbs. 6.25" L x 1.88" W x 3.38" H
<b>GRIP RANGE</b>	2.8" Max

The Short Adjustamount Kit satisfies a wide range of tool mounting requirements and provide the most versatile and flexible solution for most every equipment mounting application. Commonly combined with other PAC brackets to provide complete tool mounting solutions. **INCLUDES 1006 & 6" long section of 2019 (13/16" x 1-5/8") PAC Strut.**

- Components are molded from high quality materials
- Adjustable lock strap capable to 5400 PSI tensile strength
- 9.5" usable strap length
- Can be mounted horizontally or vertically



**List Price: \$42.95**

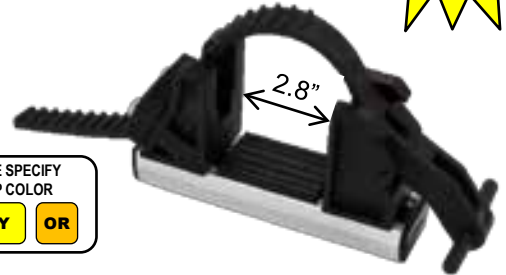

Also available with Black Strut  
Call for more information!

# ADJUSTAMOUNT KIT W/PAC STRUT - STANDARD



<b>STRAP COLORS</b> BLACK YELLOW ORANGE	<b>PRODUCT NUMBER</b> K5006-B K5006-Y K5006-OR
<b>MOUNTING HARDWARE (INCLUDED)</b>	FLAT SURFACES PAC TRAC
<b>MOUNTING HARDWARE (OPTIONAL)</b>	REFER TO PAGE 46 – INSERTS & CHANNEL NUTS
<b>PRODUCT WT. DIMENSIONS</b>	1.6 lbs. 12" L x 1.88" W x 3.4" H
<b>GRIP RANGE</b>	9" Max

The Standard Adjustamount Kit satisfies a wide range of tool mounting requirements and provide the most versatile and flexible solution for most every equipment mounting application. Commonly combined with other PAC brackets to provide complete tool mounting solutions. **INCLUDES 1006 & 12" long section of 2019 (13/16" x 1-5/8") PAC Strut.**

- Components are molded from high quality materials
- Adjustable lock strap capable to 5400 PSI tensile strength
- 28" usable strap length
- Can be mounted horizontally or vertically



**List Price:**

~~\$54.95~~

**\$48.95 For A Limited Time**

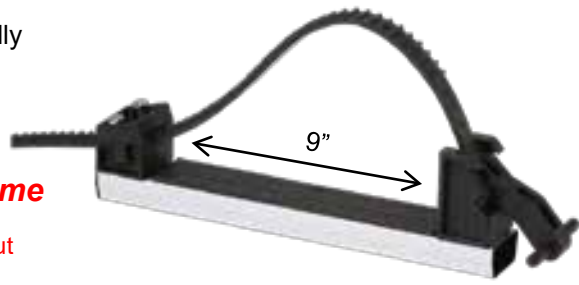

Also available with Black Strut  
Call for more information!

# ADJUSTAMOUNT KIT W/PAC STRUT - LONG



<b>STRAP COLORS</b> BLACK YELLOW ORANGE	<b>PRODUCT NUMBER</b> K5006L-B K5006L-Y K5006L-OR
<b>MOUNTING HARDWARE (INCLUDED)</b>	FLAT SURFACES PAC TRAC
<b>MOUNTING HARDWARE (OPTIONAL)</b>	REFER TO PAGE 46 – INSERTS & CHANNEL NUTS
<b>PRODUCT WT. DIMENSIONS</b>	2.3 lbs. 24" L x 1.88" W x 3.4" H
<b>GRIP RANGE</b>	21" Max

The Long Adjustamount Kit offers more tool mounting capacity than our standard Adjustamount Kit. All Adjustamounts Kits are commonly combined with other PAC brackets to provide complete tool mounting solutions. **INCLUDES 1006 & 24" long section of 2019 (13/16" x 1-5/8") PAC Strut.**

- Components are molded from high quality materials
- Adjustable lock strap capable to 5400 PSI tensile strength
- 28" usable strap length
- Can be mounted horizontally or vertically



**List Price:**

~~\$65.95~~

**\$58.95 For A Limited Time**

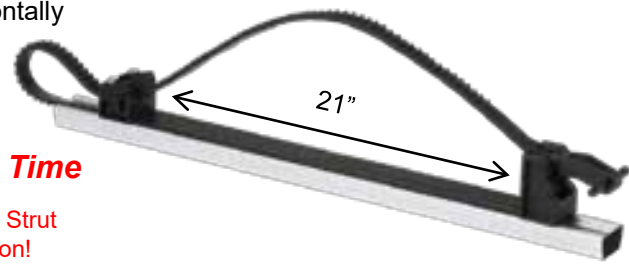

Also available with Black Strut  
Call for more information!



# ADJUSTAMOUNT KIT W/PAC STRUT HD - SHORT

<b>STRAP COLORS</b> BLACK YELLOW ORANGE	<b>PRODUCT NUMBER</b> K5006HDS-B K5006HDS-Y K5006HDS-OR
<b>MOUNTING HARDWARE (INCLUDED)</b>	FLAT SURFACES PAC TRAC
<b>MOUNTING HARDWARE (OPTIONAL)</b>	REFER TO PAGE 46 – INSERTS & CHANNEL NUTS
<b>PRODUCT WT. DIMENSIONS</b>	1.6 lbs. 6.25" L x 1.88" W x 4.12" H
<b>GRIP RANGE</b>	2.8" Max

The Short Adjustamount Kit HD satisfies a wide range of tool mounting requirements and provide the most versatile and flexible solution for most every equipment mounting application. Commonly combined with other PAC brackets to provide complete tool mounting solutions. **INCLUDES 1006 & 6" long section of 2020 (1-5/8" x 1-5/8") PAC Strut HD.**

- Components are molded from high quality materials
- Adjustable lock strap capable to 5400 PSI tensile strength
- 9.5" usable strap length
- Can be mounted horizontally or vertically

**List Price: \$49.95**



# ADJUSTAMOUNT KIT W/PAC STRUT HD - STANDARD

<b>STRAP COLORS</b> BLACK YELLOW ORANGE	<b>PRODUCT NUMBER</b> K5006HD-B K5006HD-Y K5006HD-OR
<b>MOUNTING HARDWARE (INCLUDED)</b>	FLAT SURFACES PAC TRAC
<b>MOUNTING HARDWARE (OPTIONAL)</b>	REFER TO PAGE 46 – INSERTS & CHANNEL NUTS
<b>PRODUCT WT. DIMENSIONS</b>	1.6 lbs. 12.25" L x 1.88" W x 4.12" H
<b>GRIP RANGE</b>	9" Max

The Standard Adjustamount Kit HD satisfies a wide range of tool mounting requirements and provide the most versatile and flexible solution for most every equipment mounting application. Commonly combined with other PAC brackets to provide complete tool mounting solutions. **INCLUDES 1006 & 12" long section of 2020 (1-5/8" x 1-5/8") PAC Strut HD.**

- Components are molded from high quality materials
- Adjustable lock strap capable to 5400 PSI tensile strength
- 28" usable strap length
- Can be mounted horizontally or vertically

**List Price: \$57.95**

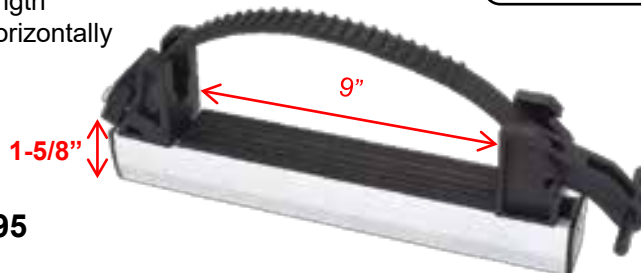

# ADJUSTAMOUNT KIT W/PAC STRUT HD - LONG

<b>STRAP COLORS</b> BLACK YELLOW ORANGE	<b>PRODUCT NUMBER</b> K5006HDL-B K5006HDL-Y K5006HDL-OR
<b>MOUNTING HARDWARE (INCLUDED)</b>	FLAT SURFACES PAC TRAC
<b>MOUNTING HARDWARE (OPTIONAL)</b>	REFER TO PAGE 46 – INSERTS & CHANNEL NUTS
<b>PRODUCT WT. DIMENSIONS</b>	2.3 lbs. 24.25" L x 1.88" W x 4.12" H
<b>GRIP RANGE</b>	21" Max

The Long Adjustamount Kit HD offers more tool mounting capacity than our standard Adjustamount Kit. All Adjustamounts Kits are commonly combined with other PAC brackets to provide complete tool mounting solutions. **INCLUDES 1006 & 24" long section of 2020 (1-5/8" x 1-5/8") PAC Strut HD.**

- Components are molded from high quality materials
- Adjustable lock strap capable to 5400 PSI tensile strength
- 28" usable strap length
- Can be mounted horizontally or vertically

**List Price: \$79.95**

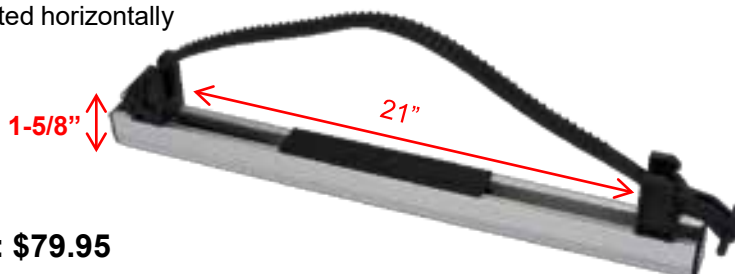

# SUPER ADJUSTAMOUNT KIT W/PAC STRUT - SHORT



<b>STRAP COLORS</b> BLACK YELLOW ORANGE	<b>PRODUCT NUMBER</b> K5050S-B K5050S-Y K5050S-OR
<b>MOUNTING HARDWARE (INCLUDED)</b>	FLAT SURFACES PAC TRAC
<b>MOUNTING HARDWARE (OPTIONAL)</b>	REFER TO PAGE 46 – INSERTS & CHANNEL NUTS
<b>PRODUCT WT. DIMENSIONS</b>	1.8 lbs. 8.25" L x 1.88" W x 4.88" H
<b>GRIP RANGE</b>	4.38" Max

The Short Super Adjustamount Kit offers more tool mounting capacity than our Short Adjustamount Kit. Super Adjustamount Kits are commonly combined with other PAC brackets to provide complete tool mounting solutions. Super Adjustamount modules are TALLER than standard Adjustamount modules. **INCLUDES 1050 & 8" long section of 2019 (13/16" x 1-5/8") PAC Strut.**

- Components are molded from high quality materials
- Adjustable lock strap capable to 5400 PSI tensile strength
- 9.5" usable strap length
- Can be mounted horizontally or vertically



List Price: \$52.95



Also available with Black Strut  
Call for more information!

# SUPER ADJUSTAMOUNT KIT W/PAC STRUT - STANDARD



<b>STRAP COLORS</b> BLACK YELLOW ORANGE	<b>PRODUCT NUMBER</b> K5050-B K5050-Y K5050-OR
<b>MOUNTING HARDWARE (INCLUDED)</b>	FLAT SURFACES PAC TRAC
<b>MOUNTING HARDWARE (OPTIONAL)</b>	REFER TO PAGE 46 – INSERTS & CHANNEL NUTS
<b>PRODUCT WT. DIMENSIONS</b>	1.8 lbs. 12" L x 1.88" W x 4.88" H
<b>GRIP RANGE</b>	8.5" Max

The Standard Super Adjustamount Kit offers more tool mounting capacity than our Standard Adjustamount Kit. Super Adjustamount Kits are commonly combined with other PAC brackets to provide complete tool mounting solutions. Super Adjustamount modules are TALLER than standard Adjustamount modules. **INCLUDES 1050 & 12" long section of 2019 (13/16" x 1-5/8") PAC Strut.**

- Components are molded from high quality materials
- Adjustable lock strap capable to 5400 PSI tensile strength
- 25" usable strap length
- Can be mounted horizontally or vertically



List Price:

~~\$67.95~~

**\$60.95 For A Limited Time**

Also available with Black Strut  
Call for more information!

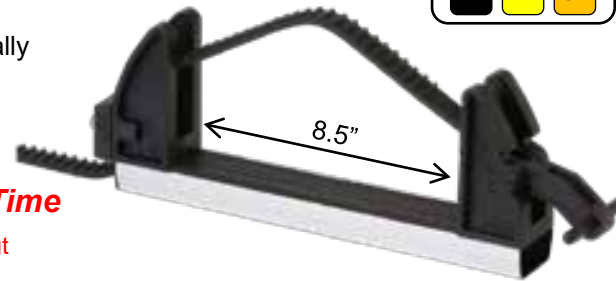

# SUPER ADJUSTAMOUNT KIT W/PAC STRUT - LONG



<b>STRAP COLORS</b> BLACK YELLOW ORANGE	<b>PRODUCT NUMBER</b> K5050L-B K5050L-Y K5050L-OR
<b>MOUNTING HARDWARE (INCLUDED)</b>	FLAT SURFACES PAC TRAC
<b>MOUNTING HARDWARE (OPTIONAL)</b>	REFER TO PAGE 46 – INSERTS & CHANNEL NUTS
<b>PRODUCT WT. DIMENSIONS</b>	2.4 lbs. 24" L x 1.88" W x 4.88" H
<b>GRIP RANGE</b>	20.38" Max

The Long Super Adjustamount Kit offers more tool mounting capacity than our Long Adjustamount Kit. **INCLUDES 1050 & 24" long section of 2019 (13/16" x 1-5/8") PAC Strut.**

- Components are molded from high quality materials
- Adjustable lock strap capable to 5400 PSI tensile strength
- 28" usable strap length
- Can be mounted horizontally or vertically



List Price:

~~\$81.95~~

**\$72.95 For A Limited Time**

Also available with Black Strut  
Call for more information!

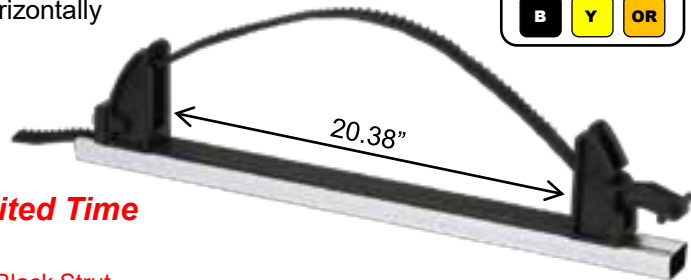

# SUPER ADJUSTAMOUNT KIT W/PAC STRUT HD - SHORT

<b>STRAP COLORS</b> BLACK YELLOW ORANGE	<b>PRODUCT NUMBER</b> K5050HDS-B K5050HDS-Y K5050HDS-OR
<b>MOUNTING HARDWARE (INCLUDED)</b>	FLAT SURFACES PAC TRAC
<b>MOUNTING HARDWARE (OPTIONAL)</b>	REFER TO PAGE 46 – INSERTS & CHANNEL NUTS
<b>PRODUCT WT. DIMENSIONS</b>	1.8 lbs. 8.25" L x 1.88" W x 5.66" H
<b>GRIP RANGE</b>	4.38" Max

The Short Super Adjustamount Kit HD offers more tool mounting capacity than our Short Adjustamount Kit HD. Super Adjustamount Kits are commonly combined with other PAC brackets to provide complete tool mounting solutions. Super Adjustamount modules are **TALLER** than standard Adjustamount modules. **INCLUDES 1050 & 8" long section of 2020 (1-5/8" x 1-5/8") PAC Strut HD.**

- Components are molded from high quality materials
- Adjustable lock strap capable to 5400 PSI tensile strength
- 9.5" usable strap length
- Can be mounted horizontally or vertically



**List Price: \$64.95**



# SUPER ADJUSTAMOUNT KIT W/PAC STRUT HD - STANDARD

<b>STRAP COLORS</b> BLACK YELLOW ORANGE	<b>PRODUCT NUMBER</b> K5050HD-B K5050HD-Y K5050HD-OR
<b>MOUNTING HARDWARE (INCLUDED)</b>	FLAT SURFACES PAC TRAC
<b>MOUNTING HARDWARE (OPTIONAL)</b>	REFER TO PAGE 46 – INSERTS & CHANNEL NUTS
<b>PRODUCT WT. DIMENSIONS</b>	1.8 lbs. 12.25" L x 1.88" W x 5.64" H
<b>GRIP RANGE</b>	8.5" Max

The Standard Super Adjustamount Kit HD offers more tool mounting capacity than our Standard Adjustamount Kit HD. Super Adjustamount Kits are commonly combined with other PAC brackets to provide complete tool mounting solutions. Super Adjustamount modules are **TALLER** than standard Adjustamount modules. **INCLUDES 1050 & 12" long section of 2019 (13/16" x 1-5/8") PAC Strut channel.**

- Components are molded from high quality materials
- Adjustable lock strap capable to 5400 PSI tensile strength
- 9.5" usable strap length
- Can be mounted horizontally or vertically



**List Price: \$70.95**

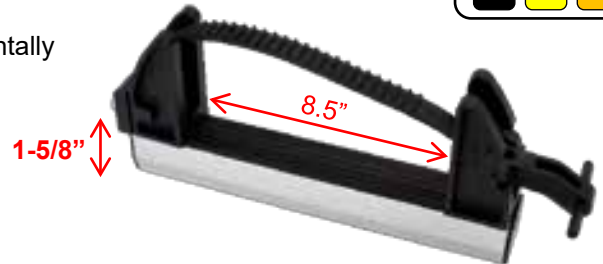

# SUPER ADJUSTAMOUNT KIT W/PAC STRUT HD - LONG

<b>STRAP COLORS</b> BLACK YELLOW ORANGE	<b>PRODUCT NUMBER</b> K5050HDL-B K5050HDL-Y K5050HDL-OR
<b>MOUNTING HARDWARE (INCLUDED)</b>	FLAT SURFACES PAC TRAC
<b>MOUNTING HARDWARE (OPTIONAL)</b>	REFER TO PAGE 46 – INSERTS & CHANNEL NUTS
<b>PRODUCT WT. DIMENSIONS</b>	2.4 lbs. 24" L x 1.88" W x 5.64" H
<b>GRIP RANGE</b>	20.38" Max

The Long Super Adjustamount Kit HD offers more tool mounting capacity than our Long Adjustamount Kit HD. **INCLUDES 1050 & 24" long section of 2020 (1-5/8" x 1-5/8") PAC Strut HD.**

- Components are molded from high quality materials
- Adjustable lock strap capable to 5400 PSI tensile strength
- 28" usable strap length
- Can be mounted horizontally or vertically



**List Price: \$83.95**

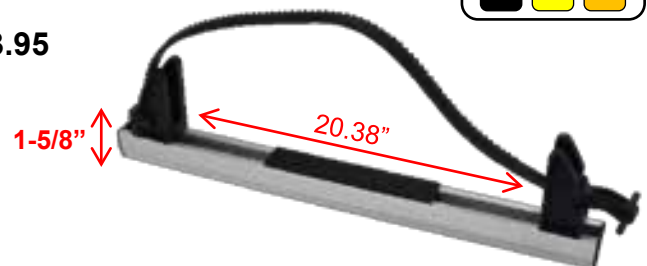

# MINI LOKS

**PAC**

<b>BASE COLOR</b> BLACK	<b>PRODUCT NUMBER</b> 1101 (Small) 1102 (Large)
<b>MOUNTING HARDWARE (INCLUDED)</b>	FLAT SURFACES PAC TRAC
<b>MOUNTING HARDWARE (OPTIONAL)</b>	N/A
<b>PRODUCT WT.</b>	.7oz/each (1101) 1.1oz/each (1102)
<b>DIMENSIONS</b>	1.5" x 1.5" x 1.56" (1101) 1.5" x 2.13" x 2.07"
<b>GRIP RANGE</b>	1101: 3/8" – 3/4" 1102: 3/4" – 1 1/8"

**SOLD IN PAIRS – The Mini Lok is a friction locking bracket perfect for flashlights, rods, cords, small hand tools, etc.**

- Works great with PAC Strut!
- Molded from high quality materials
- Weather, UV resistant
- Non-conductive
- Can be mounted horizontally or vertically



**P/N 1102 (Large)**  
**List Price: \$14.95/pair**



**P/N 1101 (Small)**  
**List Price: \$12.95/pair**



**NEW PRODUCT!**  
**MINI HOOK (P/N: 1110)**



See Page 18

# HOOKLOK

**PAC**

<b>BASE COLOR</b> BLACK	<b>PRODUCT NUMBER</b> 1001
<b>MOUNTING HARDWARE (INCLUDED)</b>	FLAT SURFACES PAC TRAC
<b>MOUNTING HARDWARE (OPTIONAL)</b>	REFER TO PAGE 46 – INSERTS & CHANNEL NUTS
<b>PRODUCT WT.</b>	0.4 lbs. / PAIR
<b>DIMENSIONS</b>	2.75" L x 2.75" W x 2.26" H
<b>GRIP RANGE</b>	1" to 1-1/4" (25.4mm-31.8mm)

**SOLD IN PAIRS - The Hooklok bracket is a versatile and easy to use friction lock product providing secure mounting for a wide variety of tools and equipment.**

**List Price: \$32.95**

- **NEW: Larger mounting base for bi-directional mounting**
- Hook feature provides additional support when mounted vertically
- Rugged injection molded components made from high quality materials
- Weather, UV resistant
- Non-conductive
- Can be mounted horizontally or vertically

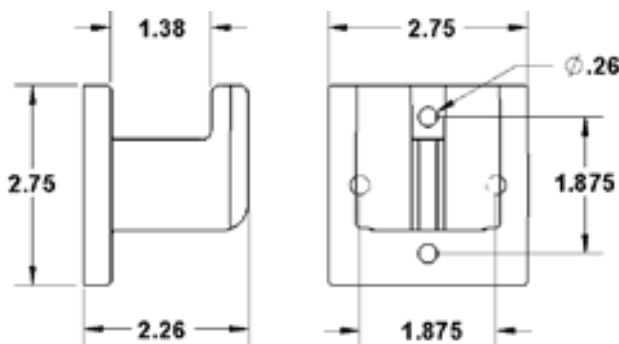

<b>STRAP COLORS</b> BLACK YELLOW ORANGE	<b>PRODUCT NUMBER</b> 1003-HDB 1003-HDY 1003-HDOR
<b>MOUNTING HARDWARE (INCLUDED)</b>	FLAT SURFACES PAC TRAC
<b>MOUNTING HARDWARE (OPTIONAL)</b>	N/A
<b>PRODUCT WT. DIMENSIONS</b>	0.2 lbs. 3.7" L x 2.7" W x 3.0" H
<b>GRIP RANGE</b>	1/8" to 1-1/2" (3.2mm-38.1mm)

The cost effective Toolok bracket is a versatile and easy to use product providing secure mounting for a wide variety of tools and equipment.

- Wider mounting base for increased stability
- Strength enhanced base material for more durability
- Thicker walled locking strap for more strength
- Molded from high quality materials
- High performance elastomer GRIPILOK is rated to 5400psi
- Weather, UV resistant
- Non-conductive
- Can be mounted horizontally or vertically

**List Price: \$29.95**

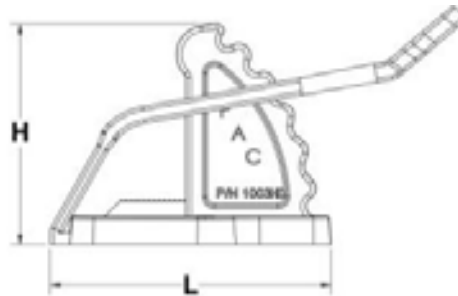
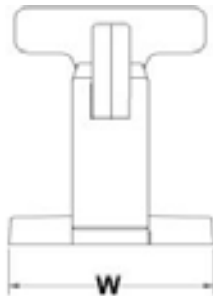

<b>STRAP COLORS</b> BLACK YELLOW ORANGE	<b>PRODUCT NUMBER</b> 1085-B 1085-Y 1085-OR
<b>MOUNTING HARDWARE (INCLUDED)</b>	FLAT SURFACES PAC TRAC
<b>MOUNTING HARDWARE (OPTIONAL)</b>	REFER TO PAGE 46 – INSERTS & CHANNEL NUTS
<b>PRODUCT WT. DIMENSIONS</b>	2.4 lbs. 24" L x 1.88" W x 4.88" H
<b>GRIP RANGE</b>	1" to 24" (25mm-610mm)

The Grip Mount is the ideal storage method for cord ends, pigtails, and small hand tools.

- Simple, fast operation
- Six flexible grip locating positions
- Three screwdriver hanging positions
- Small, compact and lightweight
- Non-metallic
- High strength materials
- Holds up to 3/4" diameter

**List Price: \$49.95**

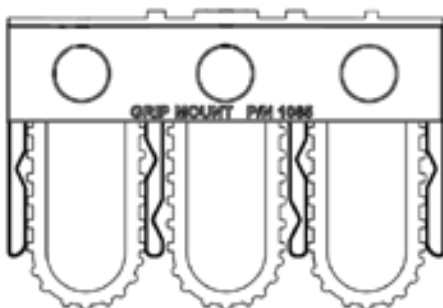



# FIRE APPARATUS INSTALLATIONS

**PERFORMANCE  
ADVANTAGE  
COMPANY**



## PAC CHALLENGE COIN

PAC Challenge Coins are double sided. Each coin comes in a protective plastic sleeve.

Price: \$10.00



## BRACKETS TO MOUNT EVERY SIZED FIRE EXTINGUISHER!



**FASTLOK ADJUSTAMOUNT KIT**  
\*Shown with water can\*  
(See page 12)

**SUPER ADJUSTAMOUNT KIT**  
\*Shown with dry chemical can\*  
(See page 11)

**4.5" CYLINDER MOUNT**  
\*Shown with 5# extinguisher\*  
(See page 23)

**3.5" CYLINDER MOUNT - TALL**  
\*Shown with 3# extinguisher\*  
(See page 23)

# PAC

# COIL-LOK

STRAP COLORS BLACK YELLOW ORANGE	PRODUCT NUMBER 1021-B 1021-Y 1021-OR
MOUNTING HARDWARE (INCLUDED)	FLAT SURFACES PAC TRAC
MOUNTING HARDWARE (OPTIONAL)	REFER TO PAGE 46 – INSERTS & CHANNEL NUTS
PRODUCT WT. DIMENSIONS	0.3 lbs. 6.6" L x 2.5" W x 3.0" H
LOAD CAPACITY	60LBS MAX

The Coil-Lok is a versatile hanger bracket which adds the security of an adjustable locking strap. Ropes, cords, chains, even hanging tools can be quickly mounted and strapped in place. A strap retainer block is included to provide an unobstructed path to hang equipment.

- Molded from high quality materials
- Adjustable lock strap capable to 5400 psi tensile strength

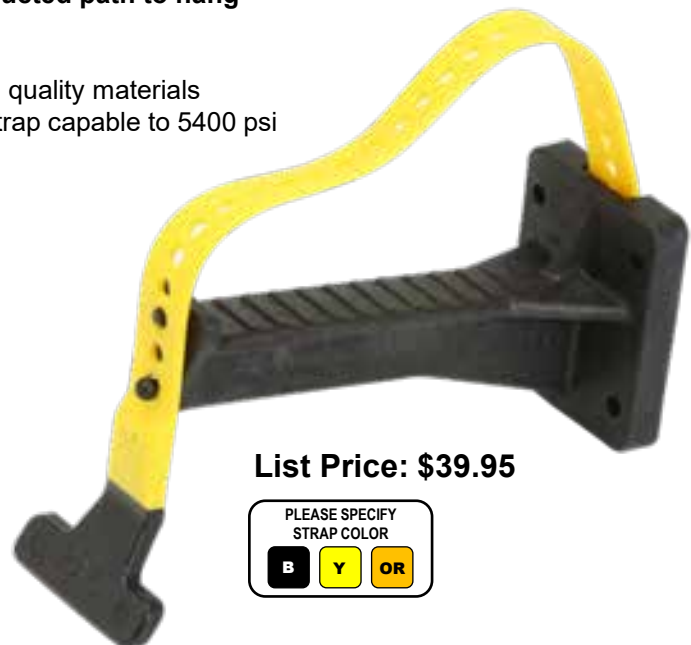
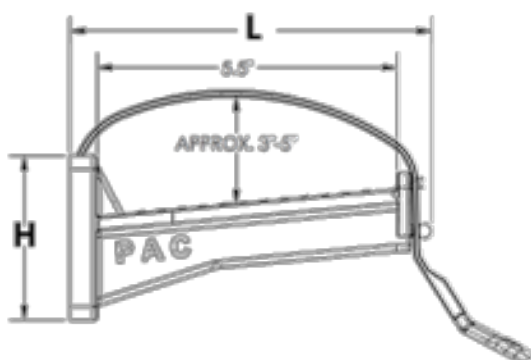

List Price: \$39.95

PLEASE SPECIFY STRAP COLOR

B  Y  OR

# STOW-N-LOK (TALL)



<b>STRAP COLORS</b> BLACK YELLOW ORANGE	<b>PRODUCT NUMBER</b> 1005-B 1005-Y 1005-OR
<b>MOUNTING HARDWARE (INCLUDED)</b>	FLAT SURFACES PACTRAC
<b>MOUNTING HARDWARE (OPTIONAL)</b>	REFER TO PAGE 46 – INSERTS & CHANNEL NUTS
<b>PRODUCT WT. DIMENSIONS</b>	0.8 lbs. 2.8" L x 2.8" W x 5.3" H
<b>GRIP RANGE</b>	1" to 1-1/2" (25.4mm-38.1mm)

Combining a friction lock action with the security of a positive locking strap, the flexible Y-shaped bracket is designed to provide a secure grip-like mount for poles, nozzles and a wide variety of other tools and equipment. The bracket can be used with or without the strap. The strap is easily adjusted for various work-holding conditions and sizes.

- Accommodates rakes and other large-head tools
- Rugged injection molded components made from high quality materials
- Weather, UV resistant
- Non-conductive
- Can be mounted horizontally or vertically

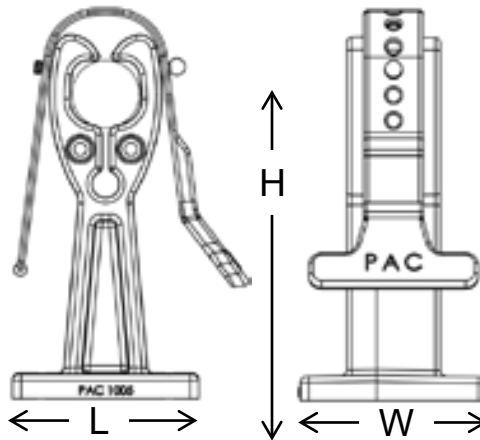

List Price: \$42.95



# STOW-N-LOK (SHORT)



<b>STRAP COLORS</b> BLACK YELLOW ORANGE	<b>PRODUCT NUMBER</b> 1005S-B 1005S-Y 1005S-OR
<b>MOUNTING HARDWARE (INCLUDED)</b>	FLAT SURFACES PACTRAC
<b>MOUNTING HARDWARE (OPTIONAL)</b>	REFER TO PAGE 46 – INSERTS & CHANNEL NUTS
<b>PRODUCT WT. DIMENSIONS</b>	0.6 lbs. 2.8" L x 2.8" W x 3.1" H
<b>GRIP RANGE</b>	1" to 1-1/2" (25.4mm-38.1mm)

Combining a friction lock action with the security of a positive locking strap, the flexible Y-shaped bracket is designed to provide a secure grip-like mount for poles, nozzles and a wide variety of other tools and equipment. The bracket can be used with or without the strap. The strap is easily adjusted for various work-holding conditions and sizes.

- Rugged injection molded components made from high quality materials
- Weather, UV resistant
- Non-conductive
- Can be mounted horizontally or vertically

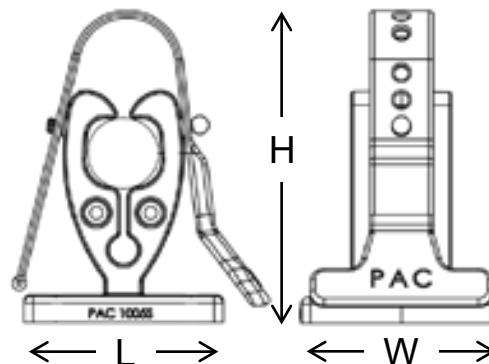

List Price: \$42.95





<b>STRAP COLORS</b> BLACK YELLOW ORANGE	<b>PRODUCT NUMBER</b> 1002-HD B 1002-HD Y 1002-HD OR
<b>MOUNTING HARDWARE (INCLUDED)</b>	FLAT SURFACES PACTRAC
<b>MOUNTING HARDWARE (OPTIONAL)</b>	REFER TO PAGE 46 – INSERTS & CHANNEL NUTS
<b>PRODUCT WT.</b>	0.4 lbs.
<b>DIMENSIONS</b>	2.75" L x 2.75" W x 5.36" H
<b>GRIP RANGE</b>	1-1/2" – 2 1/2"

The Flexmount Tall HD is a flexible Y-shaped bracket designed to provide a secure grip-like mount for poles, nozzles and a wide variety of other tools and equipment. The tall size accommodates tools with larger heads or handles. Adjustable lock strap provides additional security.

- Rugged injection molded components made from high quality materials
- Weather, UV resistant
- Non-conductive
- Can be mounted horizontally or vertically
- Easy push in and hold design with locking strap



List Price: \$39.95

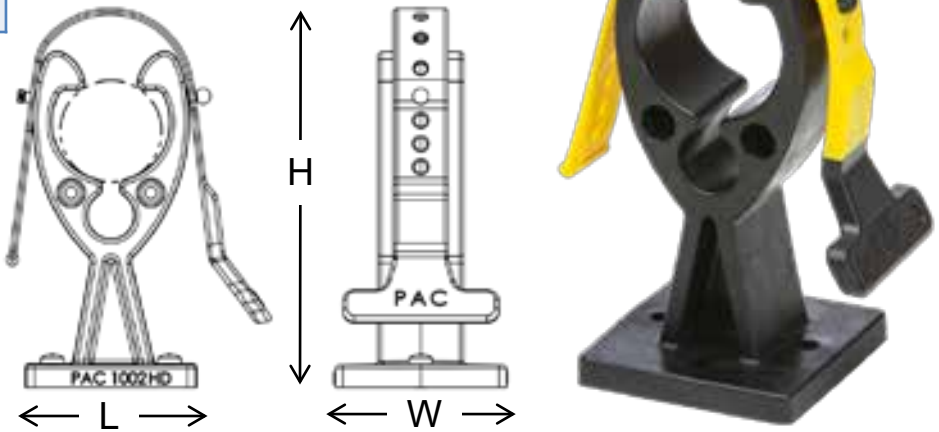

<b>STRAP COLORS</b> BLACK YELLOW ORANGE	<b>PRODUCT NUMBER</b> 1002S-HD B 1002S-HD Y 1002S-HD OR
<b>MOUNTING HARDWARE (INCLUDED)</b>	FLAT SURFACES PACTRAC
<b>MOUNTING HARDWARE (OPTIONAL)</b>	REFER TO PAGE 46 – INSERTS & CHANNEL NUTS
<b>PRODUCT WT.</b>	0.4 lbs.
<b>DIMENSIONS</b>	2.75" L x 2.75" W x 3.61" H
<b>GRIP RANGE</b>	1-1/2" – 2 1/2"

The Flexmount Short HD is a flexible Y-shaped bracket designed to provide a secure grip-like mount for poles, nozzles and a wide variety of other tools and equipment. The short version saves compartment depth. Adjustable lock strap provides additional security.

- Rugged injection molded components made from high quality materials
- Short size for poles
- Weather, UV resistant
- Non-conductive
- Can be mounted horizontally or vertically
- Easy push in and hold design with locking strap



List Price: \$39.95

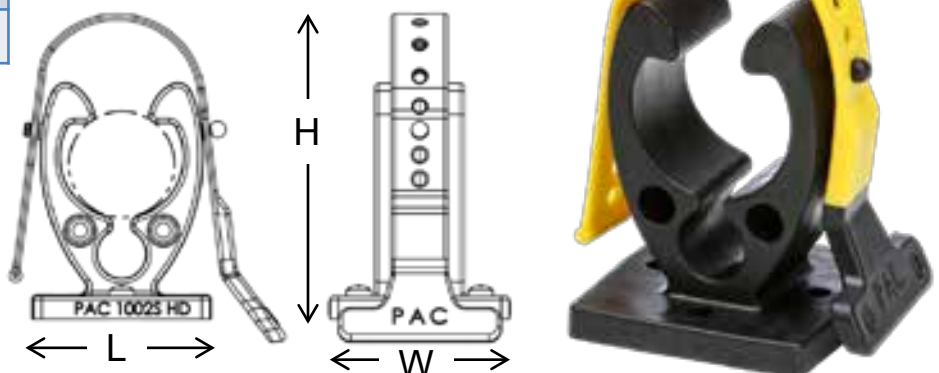

# GM HOOK



<b>BASE COLOR</b> BLACK GREEN	<b>PRODUCT NUMBER</b> 1028 1028G
<b>MOUNTING HARDWARE (INCLUDED)</b>	DOUBLE SIDED TAPE
<b>MOUNTING HARDWARE (OPTIONAL)</b>	N/A
<b>PRODUCT WT. DIMENSIONS</b>	0.1 lbs. 1.5" L x 2.5" W x 4.0" H

The GM Hook is a quick and secure way to mount or hang lightweight equipment which have a latch, hook or loop for mounting. Ideal for keys, helmets, masks and much more.

List Price: \$13.95

PLEASE SPECIFY BASE COLOR

**B** **G**

- Integrated latch to retain item
- Molded from high strength material
- Multiple uses
- Attaches with permanent double-sided tape
- No drilling required
- No mounting hardware needed



# MINI HOOK



<b>BASE COLOR</b> BLACK	<b>PRODUCT NUMBER</b> 1110
<b>MOUNTING HARDWARE (INCLUDED)</b>	FLAT SURFACES PAC TRAC
<b>MOUNTING HARDWARE (OPTIONAL)</b>	REFER TO PAGE 46 – INSERTS & CHANNEL NUTS
<b>PRODUCT WT. DIMENSIONS</b>	.7 oz / each 2.8" L x 1.5" W x 1.4" H

**SOLD IN PAIRS** – The Mini Hook is perfect for hanging lightweight items such as small bags and accessories.

- Rugged injection molded components made from high quality materials
- Weather, UV resistant
- Non-conductive
- Can be mounted horizontally or vertically
- Stainless steel fasteners provided
- Mounts to PAC tool boards, PAC Strut and other flat surfaces.



List Price: \$19.95



(Photos Courtesy of BK Kustomz)

<b>BASE COLOR</b> BLACK GREEN	<b>PRODUCT NUMBER</b> 1027 1027G
<b>MOUNTING HARDWARE (INCLUDED)</b>	FLAT SURFACES PAC TRAC
<b>MOUNTING HARDWARE (OPTIONAL)</b>	N/A
<b>PRODUCT WT. DIMENSIONS</b>	0.3 lbs. 4.3" L x 3.8" W x 3.0" H

The Loop Hook is a unique and efficient way to mount or hang equipment that utilize locking straps.

- Strong and versatile
- Molded from high strength material
- Impact resistant
- Multiple uses

List Price: \$17.95

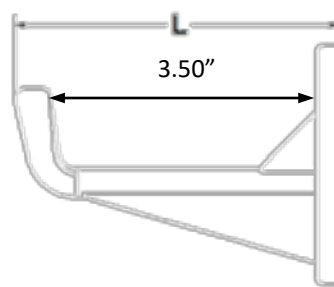
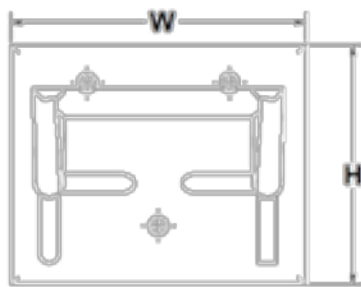

<b>BASE COLOR</b> BLACK	<b>PRODUCT NUMBER</b> 1019
<b>MOUNTING HARDWARE (INCLUDED)</b>	FLAT SURFACES PAC TRAC
<b>MOUNTING HARDWARE (OPTIONAL)</b>	REFER TO PAGE 46 – INSERTS & CHANNEL NUTS
<b>PRODUCT WT. DIMENSIONS</b>	0.4 lbs. 2.9" L x 3.5" W x 4.5" H

The Universal Hanger is designed for hanging various items such as cords, ropes, chains and tools.

- Can be used alone or in multiples
- Easy to use
- Molded from high quality materials
- Weather, UV resistant
- Non-conductive

List Price: \$18.95

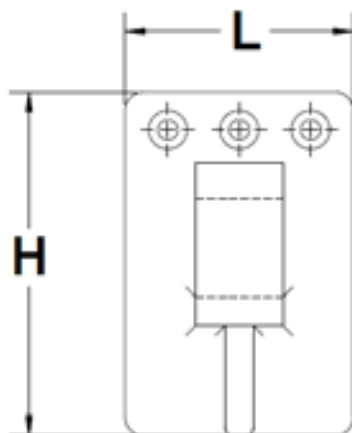
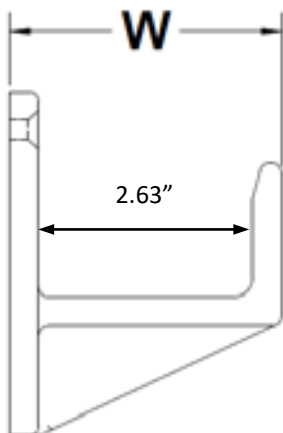

BASE COLOR BLACK	PRODUCT NUMBER 1029
MOUNTING HARDWARE (INCLUDED)	FLAT SURFACES PAC TRAC
MOUNTING HARDWARE (OPTIONAL)	REFER TO PAGE 46 – INSERTS & CHANNEL NUTS
PRODUCT WT. DIMENSIONS	0.3 lbs. 2.8" L x 2.0" W x 3.5" H

Originally designed for power tools with tubular handles, the Hook Mount provides a strong and secure hanging mount for a variety of other tools and equipment.

- Molded from high quality materials
- Easy to use
- Weather, UV resistant.
- Impact resistant
- Non-conductive

List Price: \$17.95

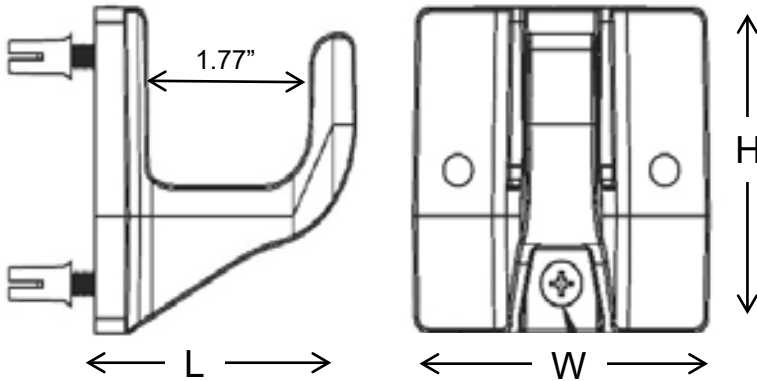

# TIE DOWN MOUNT KIT

The Tie Down Mount is a general purpose mounting bracket. The latching points can be positioned anywhere along PAC Strut providing attachments for straps, cords, etc.

- Great for securing large items
- Comes with stainless steel hardware
- Molded from high quality materials
- Easy to use
- Weather, UV resistant.



P/N K3021  
List Price: \$59.95

\*Tie Down Mount (P/N K3021) shown holding hydraulic pump with PAC Strut (P/N 2019) and Channel Cushion (P/N 8006).

\*Accessories NOT included. See pgs. 43 & 44 for PAC Strut and Channel Cushion.\*



PRODUCT NUMBER	BASE COLOR	MOUNTING HARDWARE (INCLUDED)	PRODUCT WT. DIMENSIONS
K3021	BLACK	PAC STRUT, MINI DUAL, DUAL TRAC	.7 lbs 4.18" L x 2.25" W x 1.18" H
K3021-D	BLACK	PAC STRUT, MINI DUAL, DUAL TRAC	.5 lbs 5.37" L x 2.25" W x 1.18" H



TIE DOWN MOUNT WITH DOUBLE SHACKLE (P/N K3021-D)  
List Price: \$34.95

Can be used as a hanging anchor point for various items.

The Pole Mounts are designed to support and mount poles and long handled tools when paired with other PAC brackets such as the Handle Lok, Stow-N-Lok, and Flex Mount HD.

- Molded from high quality materials
- Weather, UV resistant
- Impact resistant
- Non-conductive
- SOLD INDIVIDUALLY



**Pole Rest Mount  
(P/N 1048-1)  
List Price: \$34.95**



**Pole Guide Mount  
(P/N 1048-2)  
List Price: \$34.95**

PRODUCT NUMBER	BASE COLOR	MOUNTING HARDWARE (INCLUDED)	MOUNTING HARDWARE (OPTIONAL)	PRODUCT WT. DIMENSIONS
1048-1	BLACK	FLAT SURFACES PAC TRAC	REFER TO PAGE 46 – INSERTS & CHANNEL NUTS	.3 lbs 6.88" L x 3.5" W x 4.22" H
1048-2	BLACK	FLAT SURFACES PAC TRAC	REFER TO PAGE 46 – INSERTS & CHANNEL NUTS	.3 lbs 6.88" L x 3.5" W x 4.22" H

BASE COLOR BLACK	PRODUCT NUMBER 1007
MOUNTING HARDWARE (INCLUDED)	FLAT SURFACES PAC TRAC
MOUNTING HARDWARE (OPTIONAL)	REFER TO PAGE 46 – INSERTS & CHANNEL NUTS
PRODUCT WT. DIMENSIONS	0.2 lbs. 2.0" L x 1.5" W x 2.3" H

Universal Mounts can be used as guides, bumpers or arranged in three for locating round equipment such as extinguishers and rams. Universal Mounts are a great companion with Super Adjustamount Kits, P/N K5050.

List Price: \$11.95

- Molded from high quality material
- Simple and flexible mounting
- Weather, UV resistant
- Non-conductive
- Sold individually

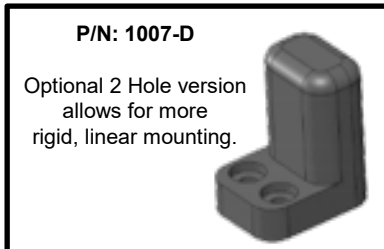
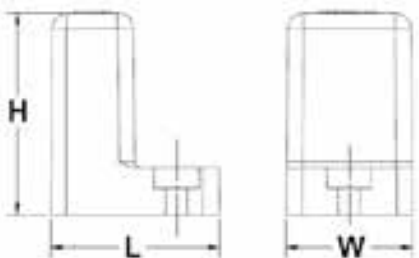

Use 3 for framing cylinders

# UTILITY POCKET



BASE COLOR BLACK	PRODUCT NUMBER 1116
MOUNTING HARDWARE (INCLUDED)	DOUBLE SIDED TAPE
MOUNTING HARDWARE (OPTIONAL)	N/A
PRODUCT WT. DIMENSIONS	4.5 oz 7.75" L x 3.88" H x 1.37" W

The Utility Pocket holds small miscellaneous hand items.

- Wall/flat surface mounted with double sided tape
- Non-metallic
- Chemical resistant material (Kydex)
- Lightweight and durable
- Flame retardant

List Price: \$19.95



# GAS & OIL MOUNTS



The Gas and Oil Mount is a simple storage mount providing a drop-in pocket for many items. The Gas and Oil Mount (P/N 1041) holds one quart size round container and one quart size rectangular oil container. The Dual Mount (P/N 1041-1) holds two quart size round containers and one quart size rectangular oil container.

- Chemical resistant material (Kydex)
- Lightweight and space saving
- High impact strength



**1041**  
List Price: \$89.95



**1041-1**  
List Price: \$99.95

PRODUCT NUMBER	BASE COLOR	MOUNTING HARDWARE (INCLUDED)	MOUNTING HARDWARE (OPTIONAL)	PRODUCT WT. DIMENSIONS
1041	BLACK	FLAT SURFACES PAC TRAC	REFER TO PAGE 46 – INSERTS & CHANNEL NUTS	.5 lbs 6.59" L x 5" W x 4" H
1041-1	BLACK	FLAT SURFACES PAC TRAC	REFER TO PAGE 46 – INSERTS & CHANNEL NUTS	.7 lbs 10.17" L x 5" W x 4" H

The Cylinder Mount is a simple storage mount providing a drop-in pocket for many cylindrical items. The 2-1/2" Cylinder Mount (P/N 1043-3) and 4-1/2" Cylinder Mount (P/N 1045-3) are a perfect fit for aerosol cans and other containers. The 3-1/2" Cylinder Mount (P/N 1044-2 Med or 1044-3 Tall) holds 1 quart metal fuel cans and fire extinguishers.

- Wall mounted
- PAC Trac compatible
- Non-metallic
- Chemical resistant material (Kydex)
- Lightweight and durable
- Flame retardant

PRODUCT NUMBER	SIZE	BASE COLOR	MOUNTING HARDWARE (INCLUDED)	MOUNTING HARDWARE (OPTIONAL)	PRODUCT WT. DIMENSIONS
1043-3	2.5"	BLACK	FLAT SURFACES PAC TRAC	REFER TO PAGE 46 – INSERTS & CHANNEL NUTS	0.33 LBS. 4.62" L x 2.8" W x 5.25" H
1044-2	3.5"	BLACK	FLAT SURFACES PAC TRAC	REFER TO PAGE 46 – INSERTS & CHANNEL NUTS	0.5 LBS. 5.4" L x 3.75" W x 5" H
1044-3	3.5"	BLACK	FLAT SURFACES PAC TRAC	REFER TO PAGE 46 – INSERTS & CHANNEL NUTS	0.6 LBS 3.4" L x 3.75" W x 6.75" H
1045-3	4.5"	BLACK	FLAT SURFACES PAC TRAC	REFER TO PAGE 46 – INSERTS & CHANNEL NUTS	0.8 LBS 6.56" L x 4.66" W x 8.87" H



**1043-3**  
List Price: \$34.95  
\*Perfect for Aerosol Cans\*

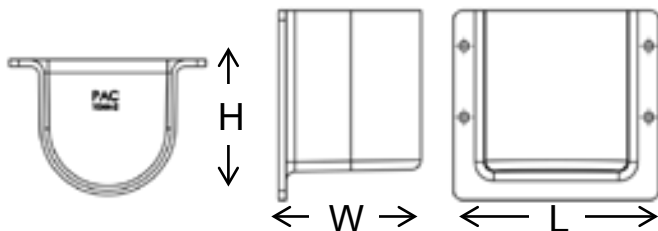

**1044-2**  
List Price: \$38.95  
\*Perfect for Tool Fuels\*



**1044-3**  
List Price: \$42.95  
\*Perfect for 3lb Extinguishers\*



**1045-3**  
List Price: \$48.95  
\*Perfect for 5lb Extinguishers and O2 Bottles\*

# RECTANGULAR MOUNTS



The Rectangular Mount is a simple storage mount providing a drop-in pocket for many rectangular items. The quart size Rectangular Mount (P/N 1046-1) is a perfect fit for small oil containers. The gallon size Rectangular Mount (P/N 1047-3) holds large gas cans.

- Wall mounted
- PAC Trac compatible
- Non-metallic
- Chemical resistant material (Kydex)
- Lightweight and durable
- Flame retardant



**1046-1**  
**List Price: \$49.95**  
*\*Quart Size\**



**1047-3**  
**List Price: \$59.95**  
*\*Gallon Size\**

PRODUCT NUMBER	SIZE	BASE COLOR	MOUNTING HARDWARE (INCLUDED)	MOUNTING HARDWARE (OPTIONAL)	PRODUCT WT. DIMENSIONS
1046-1	4.5"	BLACK	FLAT SURFACES PAC TRAC	REFER TO PAGE 46 – INSERTS & CHANNEL NUTS	0.31 LBS. 6.7" L x 2.56" W x 4.75" H
1047-3	6.75"	BLACK	FLAT SURFACES PAC TRAC	REFER TO PAGE 46 – INSERTS & CHANNEL NUTS	0.61 LBS. 8.64" L x 4.44" W x 6.25" H

# CAN MOUNTS



The Aerosol Can Mounts are simple storage mounts providing a drop-in pocket for many items. The Triple Aerosol Can Mount holds 3 aerosol cans and is a perfect fit for numerous aerosol can products. The Triple Quart Can Mount holds 3 quart size cans and is perfect for quart size fuel and oil cans.

- Chemical resistant material
- Lightweight and space saving
- High impact strength



**Triple Aerosol Can Mount**  
**P/N 1048-4**  
**List Price: \$64.95**



**Triple Quart Can Mount**  
**P/N 1048-5**  
**List Price: \$64.95**

PRODUCT NUMBER	BASE COLOR	MOUNTING HARDWARE (INCLUDED)	MOUNTING HARDWARE (OPTIONAL)	PRODUCT WT. DIMENSIONS
1048-4	BLACK	FLAT SURFACES PAC TRAC	REFER TO PAGE 46 – INSERTS & CHANNEL NUTS	1 lb 12" L x 6.88" W x 4.22" H
1048-5	BLACK	FLAT SURFACES PAC TRAC	REFER TO PAGE 46 – INSERTS & CHANNEL NUTS	1 lb 12.75" L x 6.88" H x 4.22" W



<b>STRAP COLOR</b> BLACK YELLOW ORANGE	<b>PRODUCT NUMBER</b> K5030-B K5030-Y K5030-OR
<b>MOUNTING HARDWARE (INCLUDED)</b>	FLAT SURFACES PAC TRAC
<b>MOUNTING HARDWARE (OPTIONAL)</b>	REFER TO PAGE 46 – INSERTS & CHANNEL NUTS
<b>PRODUCT WT.</b>	2.8 lbs.

The Universal Saw Kit is the perfect kit for the K12 Rescue Saw and other large Rescue Saws. Quick, one hand release lever and 4 Universal Mounts, secure your top performing saw perfectly!

- Molded from high quality materials
- Easy to use
- Weather, UV resistant
- Impact resistant
- Fast action instant release
- Non-conductive

**List Price: \$134.95**



Includes:  
4 Universal Mounts

<b>STRAP COLOR</b> BLACK YELLOW ORANGE	<b>PRODUCT NUMBER</b> K5032-B K5032-Y K5032-OR
<b>MOUNTING HARDWARE (INCLUDED)</b>	FLAT SURFACES PAC TRAC
<b>MOUNTING HARDWARE (OPTIONAL)</b>	N/A
<b>PRODUCT WT.</b>	2.7 lbs.
<b>DIMENSIONS</b>	Var. L x 9.5" W x 7.0" H

The Halligan Tool Mounting Kit is a safe, secure and dependable storage solution in any position or orientation. The Claw End and Point End Holders are combined with a Toolok bracket (P/N 1003-HD) to provide a complete tool mounting solution for a wide variety of Halligan type tools.

- Molded from high quality materials
- Easy to use
- Weather, UV resistant
- Impact resistant
- Fast action instant release
- Non-conductive

**List Price: \$106.95**



STRAP COLOR BLACK YELLOW ORANGE	PRODUCT NUMBER K5003-B K5003-Y K5003-OR
MOUNTING HARDWARE (INCLUDED)	FLAT SURFACES PAC TRAC
MOUNTING HARDWARE (OPTIONAL)	N/A
PRODUCT WT. DIMENSIONS	9.3 lbs. 33.0"L x 8.0"W x 11.5"H

The Ironslok bracket is designed for a set of irons which is a 30" Halligan tool and a 36" flathead axe. Positive locking with high strength lock strap. **FOR LARGER TOOLS, LIKE THE PIG, SEE THE NEW K5003-HD!**

- Ironslok components are molded from high quality materials
- Durable and secure
- Anodized aluminum for corrosion resistance, durability, and easy to clean
- Can be mounted horizontal or vertical



List Price: \$249.95

PLEASE SPECIFY STRAP COLOR

**B** **Y** **OR**

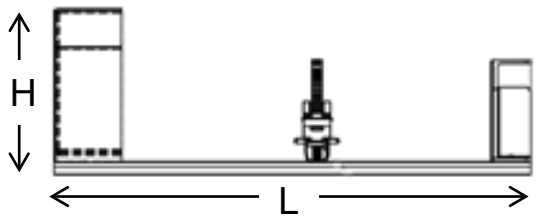

STRAP COLOR BLACK YELLOW ORANGE	PRODUCT NUMBER K5003-HD-B K5003-HD-Y K5003-HD-OR
MOUNTING HARDWARE (INCLUDED)	FLAT SURFACES PAC TRAC
MOUNTING HARDWARE (OPTIONAL)	N/A
PRODUCT WT. DIMENSIONS	9.6 lbs. 33.0"L x 10.0"W x 12.2"H

The Ironslok-HD Bracket Kit is designed for larger irons, including the PIG Axe and the FIRE MAUL! Positive locking with high strength lock strap.

- Ironslok components are molded from high quality materials
- Durable and secure
- Can be mounted horizontal or vertical

"The Ironslok helped us solve both the problems of accessibility and safety by giving us a secure way of mounting a set of "irons" directly next to a jump seat in the cab of ladder 7.... I would recommend PAC's Ironslok mounting system to other fire companies looking for a safe, effective and secure way to mount their "irons"."

**Capt. Matt Hoare**  
**Buffalo Fire Dept.**  
**Ladder 7**

List Price: \$299.95

PLEASE SPECIFY STRAP COLOR

**B** **Y** **OR**

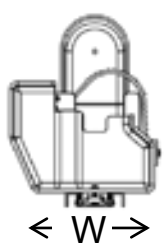
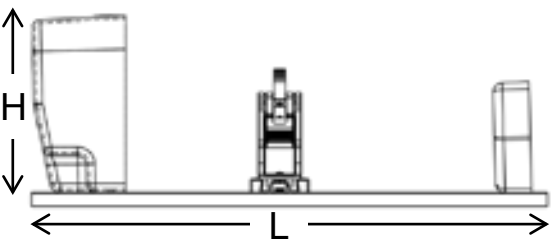

Storz Loks provide a safe secure way to store Storz hose couplings. Easy twist-on storage. New 6" size for larger Municipal Fire Departments as well as the Oil and Gas industry!

- Mounts in any position
- Weather, UV resistant
- Impact resistant
- Non-conductive

PRODUCT NUMBER	SIZE	BASE COLOR	MOUNTING HARDWARE (INCLUDED)	MOUNTING HARDWARE (OPTIONAL)	PRODUCT WT. DIMENSIONS
1040-4	4"	BLACK	FLAT SURFACES PAC TRAC	REFER TO PAGE 46 – INSERTS & CHANNEL NUTS	0.4 LBS. 5.6" L x 1.4" W x 4.5" H
1040-5	5"	BLACK	FLAT SURFACES PAC TRAC	REFER TO PAGE 46 – INSERTS & CHANNEL NUTS	0.6 LBS. 7.0" L x 1.5" W x 5.8" H
1040-6	6"	BLACK	FLAT SURFACES PAC TRAC	REFER TO PAGE 46 – INSERTS & CHANNEL NUTS	0.8 LBS 6.9" L x 1.5" W x 7.0" H



**1040-4 (4" diameter)**  
List Price: \$42.95



**1040-5 (5" diameter)**  
List Price: \$49.95



**1040-6 (6" diameter)**  
List Price: \$74.95

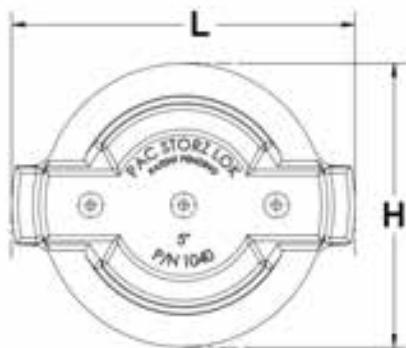

**1040-4 & 1040-5**

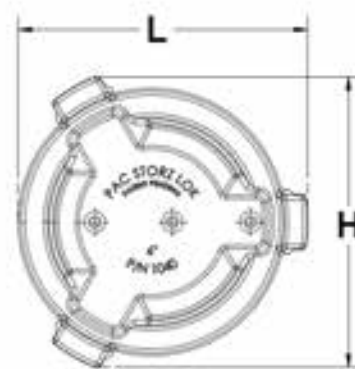

**1040-6**



PAC Adapter Loks keep your adapters organized and ready to use. Your adapters easily slide on and are retained by the locking feature. Simply depress the highly visible lock to remove the adapters!

- Molded from high quality materials
- Accepts both double male and female adapters
- Includes Spacer Ring to allow for variations in adapter lengths
- Weather, UV resistant
- Impact resistant
- Non-conductive

PRODUCT NUMBER	SIZE	BASE COLOR	MOUNTING HARDWARE (INCLUDED)	MOUNTING HARDWARE (OPTIONAL)	PRODUCT WT. DIMENSIONS
1042-1	1.5"	BLACK	FLAT SURFACES PAC TRAC	REFER TO PAGE 46 – INSERTS & CHANNEL NUTS	0.3 LBS 4.5" L x 2.5" W x 2.8" H
1042-2	2.5"	BLACK	FLAT SURFACES PAC TRAC	REFER TO PAGE 46 – INSERTS & CHANNEL NUTS	0.5 LBS 5.3" L x 3.6" W x 3.6" H
1042-D	2.5" DOUBLE	BLACK	FLAT SURFACES PAC TRAC	REFER TO PAGE 46 – INSERTS & CHANNEL NUTS	0.6 LBS 8.4" L x 3.6" W x 3.6" H



**1042-1**

List Price: \$42.95



**1042-2**

List Price: \$45.95



**1042-D**

List Price: \$63.95

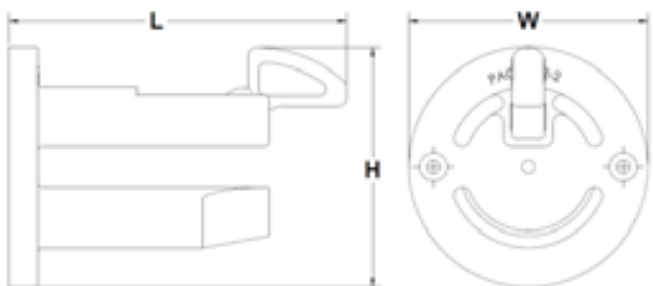



## BOLT CUTTER KIT

BASE COLOR BLACK	PRODUCT NUMBER K5029-1
MOUNTING HARDWARE (INCLUDED)	FLAT SURFACES PAC TRAC
MOUNTING HARDWARE (OPTIONAL)	REFER TO PAGE 46 – INSERTS & CHANNEL NUTS
PRODUCT WT.	0.6 lbs.

Finally, a complete PAC solution to mount your bolt cutters! Our Bolt Cutter Kit is versatile. You can mount your tool horizontally, or vertically. Hardware is included for mounting to our aluminum extrusions or to your flat surfaces.

- Molded from high quality materials

**List Price: \$48.95**

***Also Holds Wire Cutters!***



# TOOL HANGER KIT



<b>STRAP COLORS</b> BLACK YELLOW ORANGE	<b>PRODUCT NUMBER</b> K5009-B K5009-Y K5009-OR
<b>MOUNTING HARDWARE (INCLUDED)</b>	FLAT SURFACES PAC TRAC
<b>MOUNTING HARDWARE (OPTIONAL)</b>	REFER TO PAGE 46 – INSERTS & CHANNEL NUTS
<b>PRODUCT WT. DIMENSIONS</b>	1.1 lbs. (Kit) 6.0" L x 3.6" W x 4.4" H

The Tool Hanger Kit is designed to be a simple hanger solution for shovels, brooms and many other T-shaped equipment. The Tool Hanger Kit includes Tool Hanger Bracket P/N 1009 and the Handlelok Bracket P/N 1004

- Rugged injection molded components made from high quality materials
- Easy to use
- Weather, UV resistant
- Non-conductive



PLEASE SPECIFY STRAP COLOR

**B** **Y** **OR**

List Price: \$76.95 (K5009)

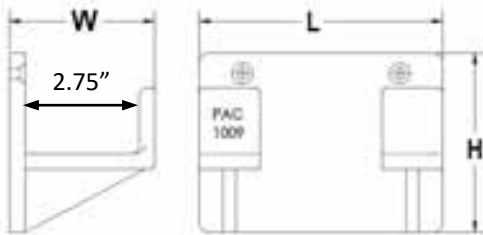

# 8-12# SLEDGE HANGER POCKET/KIT



<b>STRAP COLOR</b> BLACK YELLOW ORANGE	<b>PRODUCT NUMBER</b> K5010-12-B K5010-12-Y K5010-12-OR
<b>MOUNTING HARDWARE (INCLUDED)</b>	FLAT SURFACES PAC TRAC
<b>MOUNTING HARDWARE (OPTIONAL)</b>	REFER TO PAGE 46 – INSERTS & CHANNEL NUTS
<b>PRODUCT WT.</b>	1.5 lbs.

The Sledge Hanger/Pocket Kit is designed to hold a 8-12lb. sledge hammer, hanging OR supported as a pocket. The Sledge Hanger Kit includes both the Sledge Hanger Pocket bracket (P/N 1010-12) and the Handlelok bracket (P/N 1004).

- Molded from high quality materials
- Easy to use
- Weather, UV resistant
- Non-conductive
- Mounts several ways

List Price: \$83.95

PLEASE SPECIFY STRAP COLOR

**B** **Y** **OR**



STRAP COLOR BLACK YELLOW ORANGE	PRODUCT NUMBER K5011-B K5011-Y K5011-OR
MOUNTING HARDWARE (INCLUDED)	FLAT SURFACES PAC TRAC
MOUNTING HARDWARE (OPTIONAL)	REFER TO PAGE 46 – INSERTS & CHANNEL NUTS
PRODUCT WT.	1.8 lbs.

The Flathead Axe Hanger/Pocket Kit is designed to hold a Flathead Axe hanging OR supported as a pocket. The Flathead Axe Hanger/Pocket Kit includes the Flathead Axe Hanger/Pocket bracket (P/N 1011) and the Handlelok bracket (P/N 1004).

- Molded from high quality materials
- Easy to use
- Weather, UV resistant
- Non-conductive
- Mounts several ways

List Price: \$109.95

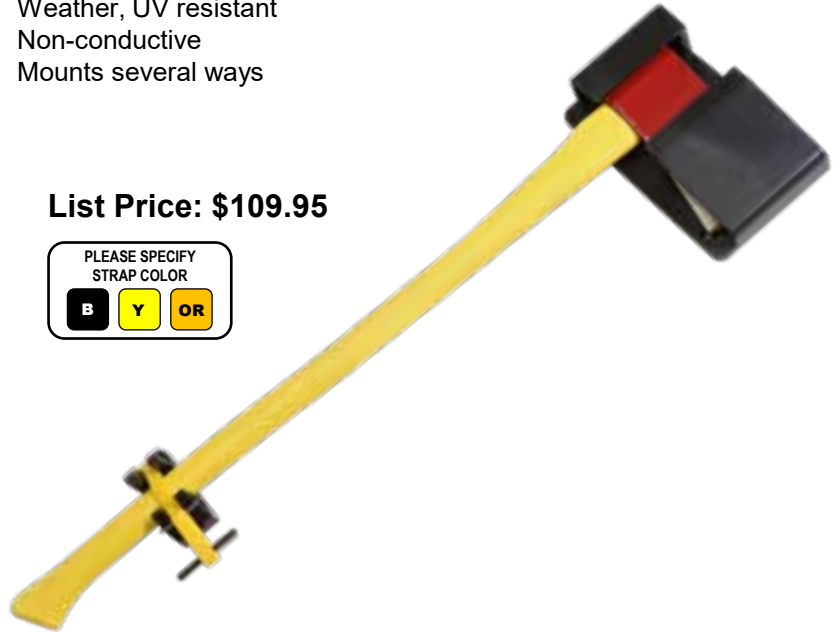

STRAP COLOR BLACK YELLOW ORANGE	PRODUCT NUMBER K5012-B K5012-Y K5012-OR
MOUNTING HARDWARE (INCLUDED)	FLAT SURFACES PAC TRAC
MOUNTING HARDWARE (OPTIONAL)	REFER TO PAGE 46 – INSERTS & CHANNEL NUTS
PRODUCT WT.	2.2 lbs.

The Pickhead Axe Hanger/Pocket Kit is designed to hold a 6lb Pickhead Axe hanging OR supported as a pocket. The Pickhead Axe Hanger/Pocket Kit includes the Pickhead Axe Hanger/Pocket bracket (P/N 1012) and the Handlelok bracket (P/N 1004).

- Molded from high quality materials
- Easy to use
- Weather, UV resistant
- Non-conductive
- Mounts several ways

List Price: \$135.95



**IN DEVELOPMENT -  
ANOTHER EXCITING  
NEW PRODUCT -  
COMING SOON!**



STRAP COLOR BLACK YELLOW ORANGE	PRODUCT NUMBER K5025-B K5025-Y K5025-OR
MOUNTING HARDWARE (INCLUDED)	FLAT SURFACES PAC TRAC
MOUNTING HARDWARE (OPTIONAL)	REFER TO PAGE 46 – INSERTS & CHANNEL NUTS
PRODUCT WT.	2.8 lbs.

The Vent Saw Kit secures Vent Saws with a strap over the bar cover and with 4 Universal Mounts. This kit can also be used for many other saw mounting applications.

- Molded from high quality materials
- High strength locking strap retains the saw bar and provides quick release
- Anodized aluminum for corrosion resistance, durability, and easy to clean
- Weather, UV resistant and non-conductive

**List Price: \$168.95**

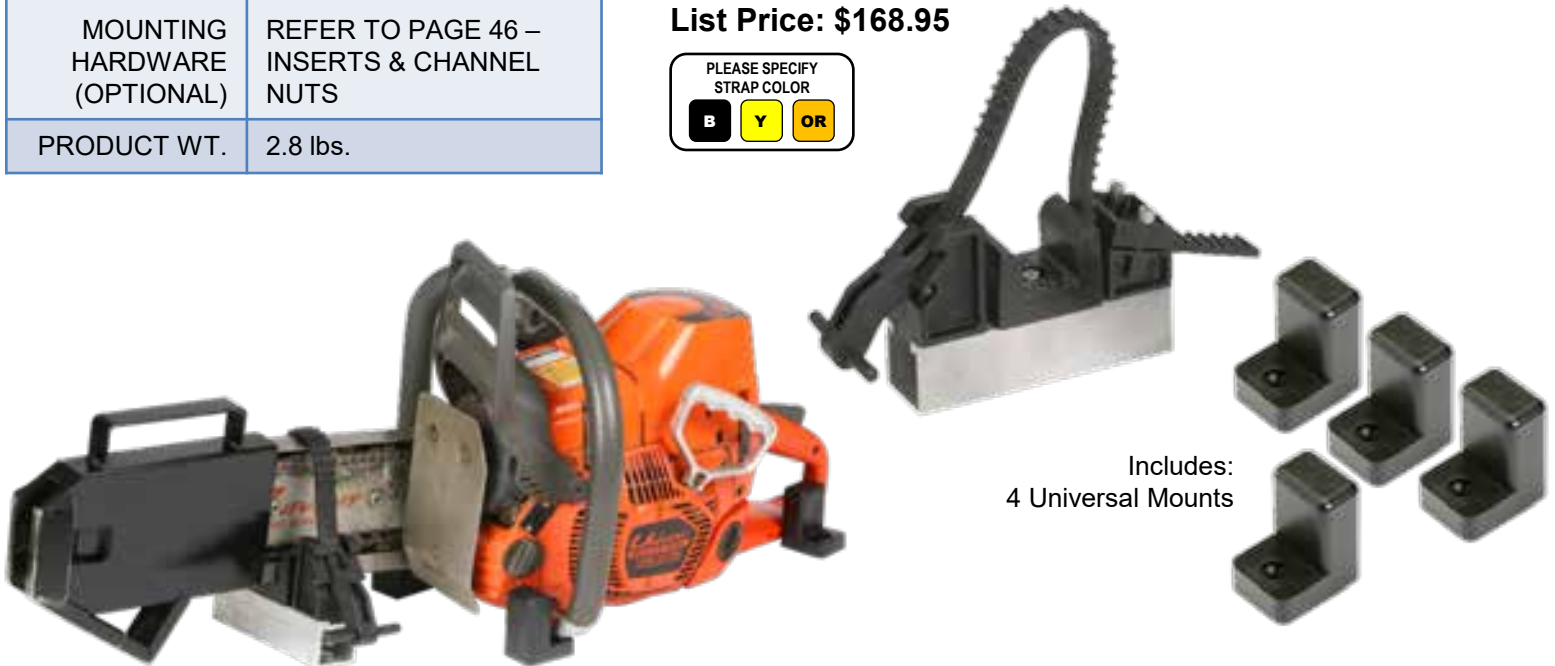

Includes:  
4 Universal Mounts



## **PAC WARRANTY**

**IF ANY PART FAILS UNDER NORMAL SERVICE  
IT WILL BE REPLACED NO CHARGE, PERIOD.**

**EXCEPT FOR THE PAC WARRANTY, WE DISCLAIM LIABILITY FOR  
INCIDENTAL AND CONSEQUENTIAL DAMAGES FOR BREACH OF ANY  
EXPRESS OR IMPLIED WARRANTY. WE DISCLAIM ANY WARRANTIES  
OF MERCHANTABILITY OR FITNESS FOR A PARTICULAR PURPOSE.**

# STRUT BASE MOUNT



BASE COLOR BLACK	PRODUCT NUMBER 2076
MOUNTING HARDWARE (INCLUDED)	FLAT SURFACES PAC TRAC
MOUNTING HARDWARE (OPTIONAL)	REFER TO PAGE 46 – INSERTS & CHANNEL NUTS
PRODUCT WT. DIMENSIONS	0.5 lbs. 4.5" L x 2.4" W x 4.4" H

The Strut Base Mount provides a secured mounting base to hold most Paratech struts and base mounts. The Strut Base Mount can also be used for many other mounting solutions.

- Molded from high quality materials
- Weather, UV resistant
- Non-conductive

**List Price: \$30.95**

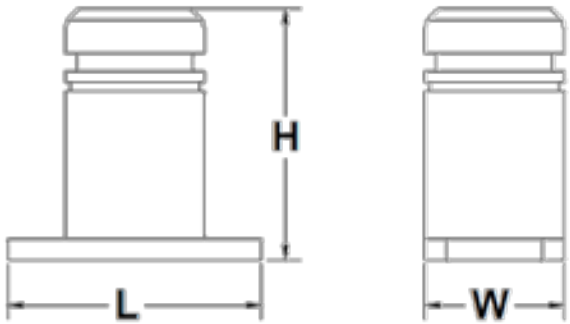

# STRUT MOUNT KIT



BASE COLOR BLACK	PRODUCT NUMBER K1022
MOUNTING HARDWARE (INCLUDED)	FLAT SURFACES PAC TRAC
MOUNTING HARDWARE (OPTIONAL)	REFER TO PAGE 46 – INSERTS & CHANNEL NUTS
PRODUCT WT.	4.9 lbs.

The Strut Mount Kit provides a secured mounting system to hold most struts.

- Molded from high quality materials
- Weather, UV resistant
- Non-conductive

**List Price: \$186.95**



## HEAVY RESCUE TOOL MT. KIT W/FASTLOK

STRAP COLOR BLACK YELLOW ORANGE	PRODUCT NUMBER K5035FL-B K5035FL-Y K5035FL-OR
MOUNTING HARDWARE (INCLUDED)	FLAT SURFACES PAC TRAC
MOUNTING HARDWARE (OPTIONAL)	REFER TO PAGE 46 – INSERTS & CHANNEL NUTS
PRODUCT WT.	4.5 lbs.

The Heavy Rescue Tool Mounting Kit with 1020 Fastlok supports, locates and secures most all rescue tools including Cutters, Spreaders and Combi tools. Works great with the eDraulic tools. Your tools can be mounted vertically, horizontally or angled.

- Heavy duty construction
- Multiple mounting positions
- Mounts most Heavy Rescue tools, even electric tools
- Anodized aluminum for corrosion resistance, durability, and easy to clean
- Weather, UV resistant
- Non-conductive



PLEASE SPECIFY STRAP COLOR

**B** **Y** **OR**

List Price: \$224.95

## HEAVY RESCUE TOOL MT. KIT W/JUMBO LOK

STRAP COLOR BLACK YELLOW ORANGE	PRODUCT NUMBER K5035JL-B K5035JL-Y K5035JL-OR
MOUNTING HARDWARE (INCLUDED)	FLAT SURFACES PAC TRAC
MOUNTING HARDWARE (OPTIONAL)	REFER TO PAGE 46 – INSERTS & CHANNEL NUTS
PRODUCT WT.	2.5 lbs.

The Heavy Rescue Tool Mounting Kit with 1070 Jumbo Lok supports, locates and secures most all rescue tools including Cutters, Spreaders and Combi tools. Your tools can be mounted vertically, horizontally or angled.

- Heavy duty construction
- Multiple mounting positions
- Mounts most Heavy Rescue tools
- Weather, UV resistant
- Non-conductive



List Price: \$169.95

PLEASE SPECIFY STRAP COLOR

**B** **Y** **OR**

## HEAVY RESCUE TOOL MT. KIT W/SUPER ADJUSTAMOUNT

STRAP COLOR BLACK YELLOW ORANGE	PRODUCT NUMBER K5035SA-B K5035SA-Y K5035SA-OR
MOUNTING HARDWARE (INCLUDED)	FLAT SURFACES PAC TRAC
MOUNTING HARDWARE (OPTIONAL)	REFER TO PAGE 46 – INSERTS & CHANNEL NUTS
PRODUCT WT.	4.1 lbs.

The Heavy Rescue Tool Mounting Kit with K5050 Super Adjustamount Kit supports, locates and secures most all rescue tools including Cutters, Spreaders and Combi tools. Your tools can be mounted vertically, horizontally or angled.

- Heavy duty construction
- Multiple mounting positions
- Mounts most Heavy Rescue tools
- Anodized aluminum for corrosion resistance, durability, and easy to clean
- Weather, UV resistant
- Non-conductive



List Price: \$174.95

PLEASE SPECIFY STRAP COLOR

**B** **Y** **OR**

# SPREADER BASE POCKET KIT W/FASTLOK



<b>BASE COLOR</b> BLACK YELLOW ORANGE	<b>PRODUCT NUMBER</b> K5026FL-B K5026FL-Y K5026FL-OR
<b>MOUNTING HARDWARE (INCLUDED)</b>	FLAT SURFACES PAC TRAC
<b>MOUNTING HARDWARE (OPTIONAL)</b>	REFER TO PAGE 46 – INSERTS & CHANNEL NUTS
<b>PRODUCT WT.</b>	4.1 lbs.

The Spreader Base Pocket with K5020 Fastlok Adjustamount Kit is designed to locate and support heavy duty rescue tools such as spreaders and combination tools.

- Can be used to mount tool laying down or standing up
- Molded form high quality materials
- Anodized aluminum for corrosion resistance, durability, and easy to clean
- Weather, UV resistant
- Impact resistant
- Non-conductive



PLEASE SPECIFY STRAP COLOR

**B** **Y** **OR**

List Price: \$149.95

# SPREADER BASE POCKET KIT W/JUMBO LOK



<b>STRAP COLOR</b> BLACK YELLOW ORANGE	<b>PRODUCT NUMBER</b> K5026JL-B K5026JL-Y K5026JL-OR
<b>MOUNTING HARDWARE (INCLUDED)</b>	FLAT SURFACES PAC TRAC
<b>MOUNTING HARDWARE (OPTIONAL)</b>	REFER TO PAGE 46 – INSERTS & CHANNEL NUTS
<b>PRODUCT WT.</b>	2.5 lbs.

The Spreader Base Pocket with 1070 Jumbo Lok is designed to locate and support heavy duty rescue tools such as spreaders and combination tools.

- Can be used to mount tool laying down or standing up
- Molded form high quality materials
- Weather, UV resistant
- Impact resistant
- Non-conductive



List Price: \$99.95

PLEASE SPECIFY STRAP COLOR

**B** **Y** **OR**

# SPREADER BASE POCKET KIT W/SUPER ADJUSTAMOUNT



<b>STRAP COLOR</b> BLACK YELLOW ORANGE	<b>PRODUCT NUMBER</b> K5026SA-B K5026SA-Y K5026SA-OR
<b>MOUNTING HARDWARE (INCLUDED)</b>	FLAT SURFACES PAC TRAC
<b>MOUNTING HARDWARE (OPTIONAL)</b>	REFER TO PAGE 46 – INSERTS & CHANNEL NUTS
<b>PRODUCT WT.</b>	3.2 lbs.

The Spreader Base Pocket with K5050 Super Adjustamount Kit is designed to locate and support heavy duty rescue tools such as spreaders and combination tools.

- Can be used to mount tool laying down or standing up
- Molded form high quality materials
- Anodized aluminum for corrosion resistance, durability, and easy to clean
- Weather, UV resistant
- Impact resistant
- Non-conductive



PLEASE SPECIFY STRAP COLOR

**B** **Y** **OR**

List Price: \$99.95

<b>BASE COLOR</b> BLACK YELLOW ORANGE	<b>PRODUCT NUMBER</b> K1022FL-B K1022FL-Y K1022FL-OR
<b>MOUNTING HARDWARE (INCLUDED)</b>	FLAT SURFACES PAC TRAC
<b>MOUNTING HARDWARE (OPTIONAL)</b>	REFER TO PAGE 46 – INSERTS & CHANNEL NUTS
<b>PRODUCT WT.</b>	4.2 LBS.

The PAC Ram Base Mount Kit with K5020 Fastlok Adjustamount is a versatile 2 sided mount. Use one side to support and locate hydraulic rams and struts from most manufacturers. Use the other side to support and locate jacks, struts and more!

- Heavy duty construction
- Mounts most Ram brands, even electric tools
- Anodized aluminum for corrosion resistance, durability, and easy to clean
- Weather, UV resistant
- Non-conductive



List Price: \$179.95



<b>BASE COLOR</b> BLACK YELLOW ORANGE	<b>PRODUCT NUMBER</b> K1022JL-B K1022JL-Y K1022JL-OR
<b>MOUNTING HARDWARE (INCLUDED)</b>	FLAT SURFACES PAC TRAC
<b>MOUNTING HARDWARE (OPTIONAL)</b>	REFER TO PAGE 46 – INSERTS & CHANNEL NUTS
<b>PRODUCT WT.</b>	2.5 lbs.

The PAC Ram Base Mount Kit with 1070 Jumbo Lok is a versatile 2 sided mount. Use one side to support and locate hydraulic rams and struts from most manufacturers. Use the other side to support and locate jacks, struts and more!

- Heavy duty construction
- Mounts most Ram brands, even electric tools
- Weather, UV resistant
- Non-conductive



List Price: \$129.95



<b>BASE COLOR</b> BLACK YELLOW ORANGE	<b>PRODUCT NUMBER</b> K1022SA-B K1022SA-Y K1022SA-OR
<b>MOUNTING HARDWARE (INCLUDED)</b>	FLAT SURFACES PAC TRAC
<b>MOUNTING HARDWARE (OPTIONAL)</b>	REFER TO PAGE 46 – INSERTS & CHANNEL NUTS
<b>PRODUCT WT.</b>	3.1 lbs.

The PAC Ram Base Mount Kit with K5050 Super Adjustamount is a versatile 2 sided mount. Use one side to support and locate hydraulic rams and struts from most manufacturers. Use the other side to support and locate jacks, struts and more!

- Heavy duty construction
- Mounts most Ram brands, even electric tools
- Anodized aluminum for corrosion resistance, durability, and easy to clean
- Weather, UV resistant
- Non-conductive



List Price: \$129.95



# AMKUS CUTTER/SPREADER KIT



STRAP COLOR BLACK YELLOW ORANGE	PRODUCT NUMBER K5021-B K5021-Y K5021-OR
MOUNTING HARDWARE (INCLUDED)	FLAT SURFACES PAC TRAC
MOUNTING HARDWARE (OPTIONAL)	REFER TO PAGE 46 – INSERTS & CHANNEL NUTS
PRODUCT WT.	2.5 lbs.

The Amkus Cutter/Spreader Kit is designed specifically for Amkus hydraulic spreaders and cutters with the “hourglass” shaped base. Tools are secured in a vertical position for easy loading and removal. The Amkus Cutter/Spreader Kit includes a Amkus Manifold Mount (P/N 4098) and Super Adjustamount Kit (P/N K5050).

- Made for Amkus Spreaders (AMK-24, AMK-22) and Amkus Cutters (AMK-21, AMK-21A)
- Molded from high quality materials
- Easy to use
- Weather, UV resistant
- Impact resistant
- Fast action instant release
- Non-conductive

List Price: \$149.95



HOURGLASS SHAPED BASE

SPECIFICALLY DESIGNED FOR:  
**AMKUS**  
RESCUE SYSTEMS



# AMKUS CUTTER/COMBI KIT



STRAP COLOR BLACK YELLOW ORANGE	PRODUCT NUMBER K5022-B K5022-Y K5022-OR
MOUNTING HARDWARE (INCLUDED)	FLAT SURFACES PAC TRAC
MOUNTING HARDWARE (OPTIONAL)	REFER TO PAGE 46 – INSERTS & CHANNEL NUTS
PRODUCT WT.	2.9 lbs.

The Amkus Cutter/Combi Kit is designed for Amkus hydraulic cutters and combi tools with the rectangular shaped base. Tools are secured in a vertical position for easy loading and removal. The Amkus Cutter/combi Kit includes a Amkus Manifold Mount (P/N 4097) and Super Adjustamount Kit (P/N K5050).

- Made for Amkus Cutters (AMK-25, AMK-25E) and Amkus Combi Tools (AMK-25C, AMK-C15)
- Molded from high quality materials
- Easy to use
- Weather, UV resistant
- Impact resistant
- Fast action instant release
- Non-conductive

List Price: \$155.95



RECTANGULAR SHAPED BASE

SPECIFICALLY DESIGNED FOR:  
**AMKUS**  
RESCUE SYSTEMS



STRAP COLOR BLACK YELLOW ORANGE	PRODUCT NUMBER K5023-B K5023-Y K5023-OR
MOUNTING HARDWARE (INCLUDED)	FLAT SURFACES PAC TRAC
MOUNTING HARDWARE (OPTIONAL)	REFER TO PAGE 46 – INSERTS & CHANNEL NUTS
PRODUCT WT.	2.9 lbs.

The Amkus Ram Mount Kit is designed for Amkus hydraulic Rams. Tools are secured in a vertical position for easy loading and removal. The Amkus Ram Mount Kit includes a Amkus Ram Base Mount (P/N 4050) and Super Adjustamount Kit (P/N K5050).

- Molded from high quality materials
- Easy to use
- Weather, UV resistant
- Impact resistant
- Fast action instant release
- Non-conductive



List Price: \$160.95



SPECIFICALLY  
DESIGNED FOR:  
**AMKUS**  
RESCUE SYSTEMS

STRAP COLOR BLACK YELLOW ORANGE	PRODUCT NUMBER K5024-B K5024-Y K5024-OR
MOUNTING HARDWARE (INCLUDED)	FLAT SURFACES PAC TRAC
MOUNTING HARDWARE (OPTIONAL)	REFER TO PAGE 46 – INSERTS & CHANNEL NUTS
PRODUCT WT.	3.1 lbs.

The Amkus Spreader/Combi Kit HD is designed for Amkus hydraulic spreaders and combi tools with a rectangular base.. Tools are secured in a vertical position for easy loading and removal. The Amkus Spreader/Combi Kit HD includes a Amkus Manifold Mount (P/N 4097) and Super Adjustamount Kit (P/N K5050-1).

- Made for Amkus Spreader (AMK-30CRT) and Amkus Combi Tool (AMK-C15)
- Comes with taller strut for the greater wall offset
- Molded from high quality materials
- Easy to use
- Weather, UV resistant
- Impact resistant
- Fast action instant release
- Non-conductive



List Price: \$158.95



SPECIFICALLY  
DESIGNED FOR:  
**AMKUS**  
RESCUE SYSTEMS







STRAP COLOR YELLOW	PRODUCT NUMBER CM6000
MOUNTING HARDWARE (INCLUDED)	REFER TO PAGE 46 – INSERTS & CHANNEL NUTS
PRODUCT WT. DIMENSIONS	10 lbs 24.5" L x 8" W x 8" H

The Standard Cylinder Mate securely stores and protects SCBA cylinders. The Cylinder Mate self-centers the air cylinder producing safe and secure storage from impact in any direction.

- Holds bottles up to 23 1/8" in length
- Molded from high quality materials
- High strength locking strap retains the air cylinder with a simple to use latching and removal process
- Weather, UV resistant
- Non-conductive
- Matching mounting holes allow individual Cylinder Mates to form storage units
- Pressure can be read while contained
- Empty cylinders can be safely stored and removed when installed backwards

**List Price: \$189.95**

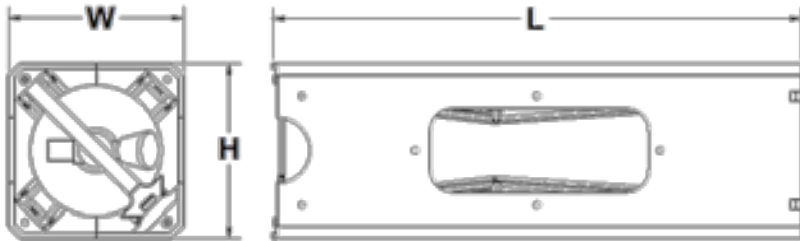

STRAP COLOR RED	PRODUCT NUMBER CM6060
MOUNTING HARDWARE (INCLUDED)	REFER TO PAGE 46 – INSERTS & CHANNEL NUTS
PRODUCT WT. DIMENSIONS	10.7 lbs. 26.5"L x 8.0"W x 8.0"H

The Extended Cylinder Mate securely stores and protects SCBA cylinders. The Cylinder Mate self-centers the air cylinder producing safe and secure storage from impact in any direction.

- Holds bottles up to 25" in length
- Molded from high quality materials
- High strength locking strap retains the air cylinder with a simple to use latching and removal process
- Weather, UV resistant
- Non-conductive
- Matching mounting holes allow individual Cylinder Mates to form storage units
- Pressure can be read while contained
- Empty cylinders can be safely stored and removed when installed backwards

**List Price: \$249.95**

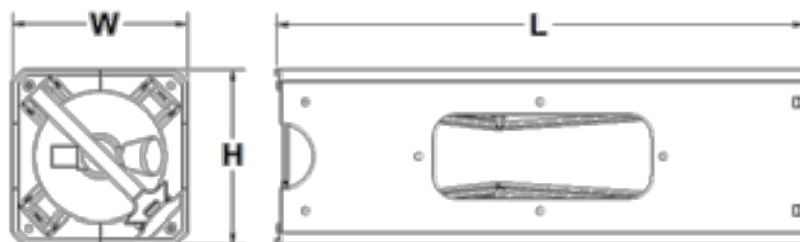

# CYLINDER MATE 12 PACK CART



STRAP COLOR YELLOW RED	PRODUCT NUMBER CM6000-12 CM6060-12
WHEEL DIAMETER	8"
PRODUCT WT.	155 lbs. (CM6000-12) 166 lbs (CM6060-12)
DIMENSIONS CM6000-12 CM6060-12	24.5" L x 24" W x 45" H 26.5" L x 24" W x 45" H

The Cylinder Mate Mobile Storage Units are assembled from individual Cylinder Mates. Standard units of 12 & 16 are available. Mobile units allow air cylinders to be moved or relocated easily for transfer or filling.

- Heavy duty pneumatic wheels with locks on front wheels
- Up to 300lb capacity
- Pull handle for easy control
- P/N CM6000-12
- P/N CM6060-12
- Empty cylinders can be safely stored and removed when installed backwards with new design



List Price: \$1,842.95 (CM6000-12)

List Price: \$2,047.95 (CM6060-12)

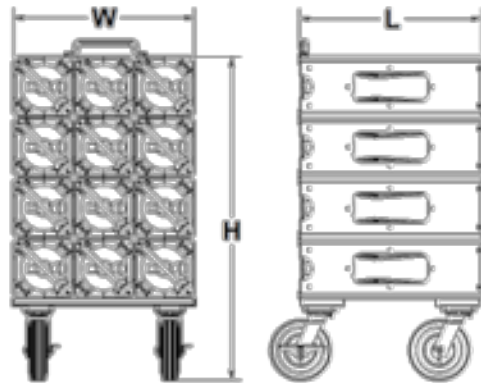

# CYLINDER MATE 16 PACK CART



STRAP COLOR YELLOW RED	PRODUCT NUMBER CM6000-16 CM6060-16
WHEEL DIAMETER	8"
PRODUCT WT.	201 lbs. (CM6000-16) 214 lbs (CM6060-16)
DIMENSIONS CM6000-16 CM6060-16	24.5" L x 32" W x 45" H 26.5" L x 32" W x 45" H

The Cylinder Mate Mobile Storage Units are assembled from individual Cylinder Mates. Standard units of 12 & 16 are available. Mobile units allow air cylinders to be moved or relocated easily for transfer or filling.

- Heavy duty pneumatic wheels with locks on front wheels
- Up to 300lb capacity
- 2 Pull handles for easy control
- P/N CM6000-16 (30-45 min cylinders)
- P/N CM6060-16 (60 min cylinders)
- Empty cylinders can be safely stored and removed when installed backwards with new design



List Price: \$2,336.95 (CM6000-16)

List Price: \$2,711.95 (CM6060-16)

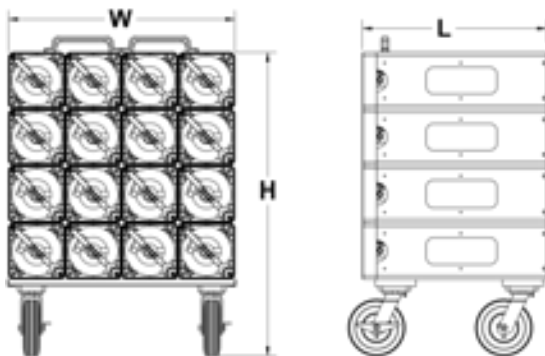

<b>BASE COLOR</b> BLACK	<b>PRODUCT NUMBER</b> LP002-10
<b>MOUNTING HARDWARE (INCLUDED)</b>	REFER TO PAGE 46 – INSERTS & CHANNEL NUTS
<b>PRODUCT WT. DIMENSIONS</b>	1 oz. 3 5/8" L x 1 1/8" W x 1/16" H

Label Plates are available in packs of 10. Each package comes with 10 white labels to make labeling your tools easy.

- Durable reusable material
- Accepts self stick labels (2 1/2" x 1")
- Chemical resistant
- High impact strength
- Mounting screws for PAC Trac available

**List Price: \$12.95**

**With PAC Trac Hardware: \$16.95**



**GENUINE 3M TAPE - MADE IN U.S.A**

*Additional colors and sizes available  
BUT LEAD TIMES MAY APPLY!*

<b>GRADE</b>	<b>SCOTCHLITE REFLECTIVE</b>
<b>WIDTH</b>	1/2"
<b>COLORS</b>	<b>PRODUCT #</b>
WHITE	50-010 (1/2" wide)
YELLOW	50-071 (1/2" wide)
RED	50-072 (1/2" wide)
ORANGE	50-014 (1/2" wide)
<b>SOLD BY:</b>	12" (1 FOOT) INCREMENTS



**- Call For Prices -**

<b>GRADE</b>	<b>DIAMOND GRADE</b>
<b>WIDTH</b>	1 1/2"
<b>COLORS</b>	<b>PRODUCT #</b>
WHITE	15-010
RED/WHITE	15-326
<b>SOLD BY:</b>	12" (1 FOOT) INCREMENTS

**Genuine 3M Scotchlite Reflective Tape (0.5" wide only)**

Scotchlite™ shows good visibility at day and night-time. Retains most of its retroreflectivity when totally wet. The film resists fuel vapors & spills. Sized for all PAC aluminum boards and brackets.



**Genuine 3M Diamond Grade Conspicuity Tape (1.5" wide only)**

Enhance the visibility of tool boards, tools, trailers, etc. Highly durable- providing up to ten years of field performance. Diamond grade has excellent angularity which provides enhanced visibility for drivers. Meets NHTSA conspicuity requirements. Large width for Z70 series Tool boards and for SO74 series swing outs.

# PAC STRUT



FINISH CLEAR BLACK	PRODUCT NUMBER 2019 2019-B
THICKNESS	.078"
PRODUCT WT. DIMENSIONS	.45 lbs/ft 1-5/8" W x 13/16" H

Commonly used to mount various tools and other systems, PAC Strut is a support system which can be supplied in various lengths. PAC supplies this product in Aluminum for easy installation and corrosion resistance.

- Beautiful clear hard anodized finish
- Guide groove in the base for easy centering when drilling mounting holes
- Compatibility with industry standard fittings
- Shallow channel
- Corrosion resistant
- Plain back
- Available by the inch up to 120" max

List Price: \$0.65 / INCH

USE WITH CHANNEL  
NUTS 7018, 7053, 7054

REFER TO PAGE 46 –  
INSERTS & CHANNEL NUTS

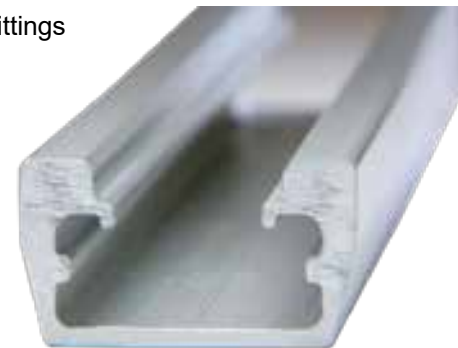
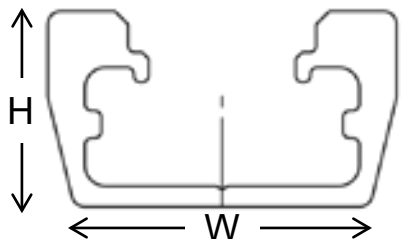

Channel Cushion  
\*Sold Separately\*  
(P/N 8006, \$0.82/inch)

PAC End Caps  
\*Sold Separately\*  
(2019EC-2, \$6.95/pair)



Black Strut Also Available!  
Call for more information!



# PAC STRUT HD



MATERIAL ALUMINUM	PRODUCT NUMBER 2020
THICKNESS	.109"
PRODUCT WT. DIMENSIONS	.76 lbs/ft 1-5/8" W x 1-5/8" H

PAC Strut HD is also a commonly used PAC Strut framing channel. PAC supplies this product in Aluminum for easy installation and corrosion resistance.

- Beautiful clear hard anodized finish
- Deep channel
- Corrosion resistant
- Plain back
- Available by the inch up to 120" max

List Price: \$0.75 / INCH

USE WITH STEEL CHANNEL  
NUTS 7052

REFER TO PAGE 46 –  
INSERTS & CHANNEL NUTS

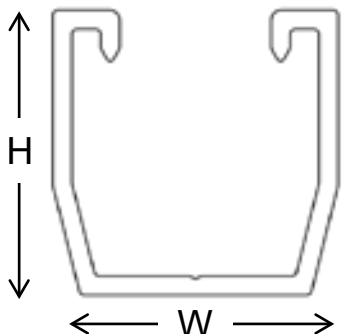

PAC End Caps Available  
\*Sold Separately\*  
(2020EC-2, \$6.95/pair)



<b>BASE COLOR</b> BLACK	<b>PRODUCT NUMBER</b> 8006
<b>DIMENSIONS</b>	1-5/8" W x 3/4" H

The PAC Strut Channel Cushion provides insulation and a firm bottom grip between the mounted object and PAC Strut and family of extrusions.

- Works with PAC Strut, PAC Strut HD, Dual Trac, Double Dual Trac, and Mini Dual Trac
- Also works with Unistrut P1000 & P4000
- Tough 3/16" thick flange
- Molded for extreme long life
- Easily snaps in place
- Available by the inch up to 60" max

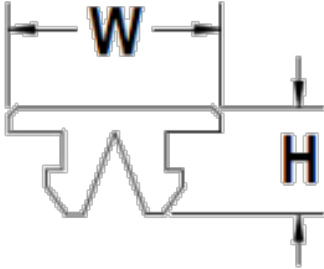

**List Price: \$0.82 / INCH**



<b>BASE COLOR</b> ALUMINUM	<b>PRODUCT NUMBER</b> PSM
<b>DIMENSIONS</b>	6.13" W x 6.63" H x 30" L MAX

The Shelf Mount provides a horizontal mounting surface of PAC TRAC (DUAL TRAC P/N 7020) which is compatible with many PAC brackets and hardware. The Shelf Mount provides a rest for mounting heavy rescue tool pockets and other support and locating brackets. The Shelf Mount makes a great add-on to PAC Vertical Slide out tool boards.

- All aluminum construction
- Shelf is compatible with many PAC brackets
- Up to 30" wide
- Heavy duty capacity (up to 50 lbs)
- Mounting hardware included
- Compatible with PAC pockets, adapter mounts and supports.
- Compatible with PAC tool boards

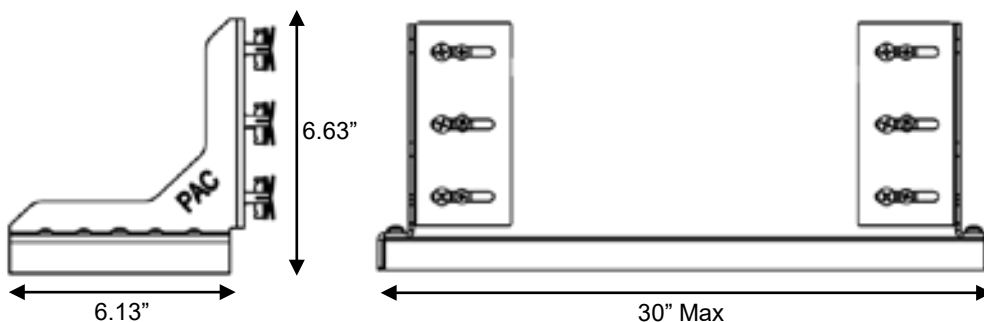

**List Price: \$127.95**

# MINI DUAL CORNER CONNECTOR



MATERIAL ALUMINUM	PRODUCT NUMBER 3018
MOUNTING HARDWARE (INCLUDED)	PAC TRAC
MOUNTING HARDWARE (OPTIONAL)	REFER TO PAGE 46 – INSERTS & CHANNEL NUTS
PRODUCT WT. DIMENSIONS	.11 lbs. 2.8" L x 1.5" W x 1.5" H

The Mini Dual Corner Connector quickly connects corners, sides and bottom sections of PAC extrusions.

- Works best with Mini Dual Trac
- 1/8" thick anodized aluminum for corrosion resistance
- Sold In Pairs



List Price: \$23.95/Pair

# DUAL TRAC CORNER CONNECTOR



MATERIAL ALUMINUM	PRODUCT NUMBER 3027
MOUNTING HARDWARE (INCLUDED)	PAC TRAC
MOUNTING HARDWARE (OPTIONAL)	REFER TO PAGE 46 – INSERTS & CHANNEL NUTS
PRODUCT WT. DIMENSIONS	.27lbs 5.75" L x 2" W x 2" H

The Dual TRAC Corner Connector quickly connects corners, sides and bottom sections of larger PAC extrusions.

- Works best with Dual TRAC and Double Dual Trac
- 1/8" thick anodized aluminum for corrosion resistance
- Sold In Pairs



List Price: \$25.95/Pair

# CUP MOUNT



BASE COLOR BLACK	PRODUCT NUMBER 1033
MOUNTING HARDWARE (INCLUDED)	FLAT SURFACES
MOUNTING HARDWARE (OPTIONAL)	REFER TO PAGE 46 – INSERTS & CHANNEL NUTS
PRODUCT WT. DIMENSIONS	.05 lbs. 4" W x 15/32"

A protective base which also provides easy positioning and locating, under many different types of equipment including SCBA Cylinders, Rams, Jacks, Saws and Hydraulic Pumps. Installs easily without tools. Cup Mounts are a logical companion to Fastlok Adjustamount, Jumbo Lok and other PAC brackets.



List Price: \$13.95 EACH









List Price: \$52.95 (4 PACK, K5033)

IMAGE	PRODUCT NUMBER	INCLUDES	THREAD SIZE	MATERIAL	USED FOR	LIST PRICE
	<b>7002</b>	<b>(40) INSERTS &amp; ASST. SCREWS</b>	10-24	PAC NYLON	ALL PAC	<b>\$9.99</b>
	<b>7016-100</b>	<b>(100) INSERTS ONLY</b>	10-24	PAC NYLON	ALL PAC	<b>\$11.99</b>

PAC's Traclok Inserts hold brackets to our entire PAC TRAC family of extrusions. These inserts expand and lock in the tracks when the included screws are tightened. Traclok Inserts are tough and durable. Loosen the screws and the Traclok Inserts can be moved or removed.

- Works with entire PAC TRAC family
- Durable, non-corrosive
- Installs easily
- Remove, reuse and reposition easily



IMAGE	PRODUCT NUMBER	THREAD SIZE	MATERIAL	USED FOR	LIST PRICE
	<b>3023</b>	10-24	PAC NYLON	DUAL TRAC(S) & PAC STRUT 2019	<b>\$0.85</b>
	<b>3024</b>	1/4-20	PAC NYLON	DUAL TRAC(S) & PAC STRUT 2019	<b>\$0.85</b>
	<b>2104</b>	1/4-20	STEEL / NYLON	DUAL TRAC(S) & PAC STRUT 2019	<b>\$2.59</b>
	<b>2023</b>	1/4-20	GALVANIZED STEEL	DUAL TRAC(S) & PAC STRUT 2019	<b>\$3.89</b>
	<b>2010</b>	1/4-20	GALVANIZED STEEL	UNISTRUT P4000	<b>\$3.09</b>
	<b>2018</b>	1/4-20	GALVANIZED STEEL	UNISTRUT P1000 & PAC STRUT HD	<b>\$2.99</b>
	<b>3014</b>	1/4-20	<b>STAINLESS STEEL</b>	DUAL TRAC(S) & PAC STRUT 2019	<b>CALL</b>
	<b>3022</b>	1/4-20	<b>STAINLESS STEEL</b>	UNISTRUT P4000	<b>CALL</b>

These Channel Nuts hold brackets to our PAC TRAC and DUAL TRAC extrusions. Also included are channel nuts specifically for Unistrut channels. These inserts lock in the tracks when the screw is tightened. Loosen the screws and the Channel Nuts can be moved or removed.

- Durable, non-corrosive
- Installs easily
- Remove, reuse, reposition easily



**PERFORMANCE  
ADVANTAGE  
COMPANY**

# TRADE SHOWS



**FDIC 2019 –  
Three Generations of Youngs**



**2019 ESTRA TOW SHOW**



**FDIC 2019**



**2019 E-ONE  
OPEN HOUSE**



**2019 GIE Show**



**NYS FIRE CHIEFS 2019**



**OLD FORGE FIRE SCHOOL 2019**





The PAC TRAC Family of products are designed to provide a unique and versatile mounting surface for tools and equipment.

PAC TRAC boards have special grooves or channels which allow the assembly of tool boards and the mounting of brackets and equipment.

PAC TRAC boards are extruded from 6063-T5 aluminum and available in standard lengths of 50", 70" and 120". Boards are available in width increments of 3-3/4", 5-3/4" and 8-5/8".

The Pac Trac family of extrusion is NFPA 1901 Impact G Force & MIL Grade B certified as a mounting structure for testing tool brackets.



**ASSEMBLY METHODS**

Assemble tool boards with **Z-Mount** (P/N 7001 and 7001D)

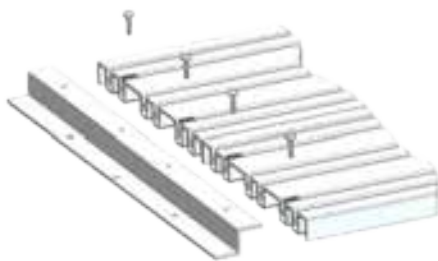

Z & U Channel Kits come in pairs **AND** include hardware. Choose your board type and the number of sections. There is a corresponding frame kit to make your custom tool board assembly simple!

Assemble double sided tool boards with **U-Channel** (P/N 7009)

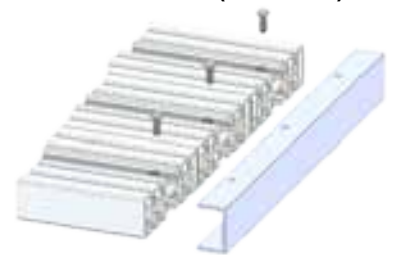

**ATTACHMENT METHODS**



SCREW MOUNTING WITH Z-MOUNT



TOOLBOARD ASSEMBLIES

**BRACKET MOUNTING METHODS**



**Trac Lok Inserts** (P/N 7016)

PAC brackets can be installed without drilling holes. Brackets can be relocated, removed or re-oriented easily. Brackets are attached to PAC TRAC products with PAC Trac Lok inserts or optional PAC channel nuts\*. For heavy duty applications use optional Steel Uni-Strut channel nuts\*.



**Channel Nuts** (P/N 3023 & P/N 3024)

\* Mini(7050), Dual(7020) & Double Dual Trac (7040) only

PAC Trac tool boards provide quick, secure installation of brackets, all without drilling holes. Uses lab tested special high strength fasteners to cleanly and effectively mount your tools. PAC Trac's permitted uses include horizontal or vertical slide-out tool boards, swing out tool boards and adjustable self-supporting shelving among other items.



Call our specialists  
to configure your custom  
tool mounting board.  
(1-888-514-0083)

**PLEASE SPECIFY DESIRED  
FINISHED SIZES WITH ORDER!!**



A low profile, full extension slide out tool board that provides easy access to tools and equipment. Locks in and out. Ready for bracket mounting. Board material not included. Available in 2 versions for standard or shallow compartments.

**PLEASE SPECIFY DESIRED FINISHED SIZES WITH ORDER!!**



# HD VERTICAL SLIDE OUT TOOL BOARDS



A full extension slide out double sided tool board, that provides easy access to tools and equipment. Locks in and out. Ready for bracket mounting. Board material not included. Available in 2 versions for standard or shallow compartments. (Please specify left or right hand side of the compartment when ordering.)



**PLEASE SPECIFY  
DESIRED FINISHED  
SIZES WITH ORDER!!**



**PLEASE SPECIFY DESIRED  
FINISHED SIZES WITH ORDER!!**



**Available in right  
and left side slides**



# SWING OUT TOOL BOARDS



Swing out tool boards are a great way to double your mounting space. Brackets and equipment can be mounted to both sides of the tool board. Multiple configurations create the most efficient use of space and allow better accessibility. Latch closed and open for security.

LEFT HAND



RIGHT HAND

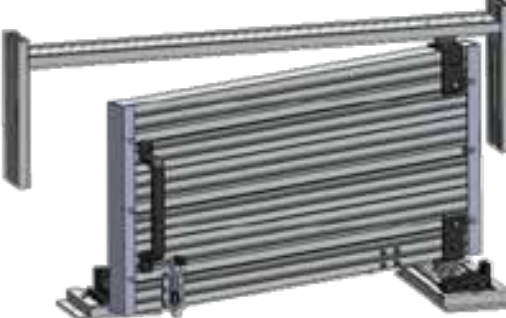

OVERLAP STYLES



DOUBLE DOOR STYLES



**PLEASE SPECIFY DESIRED FINISHED SIZES WITH ORDER!!**





PAC is located 10 minutes from the City of Buffalo in Lancaster, NY. Call and make an appointment for a company tour. See how our huge "Classroom", displaying many real-world tool mounting examples, will inspire your department.



VISIT US OR MAIL US AT:  
PERFORMANCE ADVANTAGE CO.  
10 WEST MAIN STREET  
LANCASTER, NY 14086

Our building houses the Greater Lancaster Fire Fighting Museum. We are dedicated to preserving the Fire History of Lancaster, NY. The newest exhibits feature two companies from Lancaster, NY; fire fighting innovators - Young Fire Equipment and Scott Aviation!

Jerry would be glad to give a tour!  
Email [Jerry@pactoolmounts.com](mailto:Jerry@pactoolmounts.com).

The museum also sponsors the hugely popular Lancaster Christmas Fire Truck parade.



PAC was founded on the experience of Dick Young, former President of Young Fire Equipment. His experience and innovation in the Fire Truck market is what makes PAC Tool Mounts superior. Our knowledgeable team has lifetimes of experience in the Industry. Our passion shows in our proven designs.



**TOOL MOUNTING SYSTEMS**  
**PACTOOLMOUNTS.COM**

**TRADITION - SAFETY - VALUE**

**PERFORMANCE  
ADVANTAGE  
PAC COMPANY**



**CONTACT US TODAY!**

**TAKE ADVANTAGE OF OUR  
INDUSTRY LEADING  
TOOL MOUNTING SOLUTIONS  
& CUSTOMER SERVICE!!**

**WEB: [WWW.PACTOOLMOUNTS.COM](http://WWW.PACTOOLMOUNTS.COM)  
EMAIL: [INFO@PACTOOLMOUNTS.COM](mailto:INFO@PACTOOLMOUNTS.COM)**

**OUR CUSTOMER SERVICE TEAM**

<b>GREG YOUNG</b> <b>GREG@PACTOOLMOUNTS.COM</b>	<b>VP SALES &amp; OPERATIONS</b>
<b>TAMMY TRZEPACZ</b> <b>TAMMY@PACTOOLMOUNTS.COM</b>	<b>INTERNATIONAL SALES TECHNICAL SUPPORT</b>
<b>TOM TRZEPACZ</b> <b>TOM@PACTOOLMOUNTS.COM</b>	<b>FIRE / UTILITY / TOWING / LANDSCAPING TECHNICAL SUPPORT AND PRODUCT TRAINING</b>
<b>MIKE MCGUIRE</b> <b>MIKE@PACTOOLMOUNTS.COM</b>	<b>FIRE / LAW ENFORCEMENT / MILITARY SALES TECHNICAL SUPPORT</b>

**>>>> SEND PURCHASE ORDERS TO [ORDERS@PACTOOLMOUNTS.COM](mailto:ORDERS@PACTOOLMOUNTS.COM) <<<<  
(PLEASE SPECIFY DESIRED FINISHED SIZES WITH ORDER!!)**

**PERFORMANCE ADVANTAGE COMPANY  
10 WEST MAIN STREET  
LANCASTER, NY 14086  
PHONE TOLL FREE: 1-888-514-0083  
FAX TOLL FREE: 1-877-741-9206**

